

Smappee EV Wall ^{LITE}

Installation manual

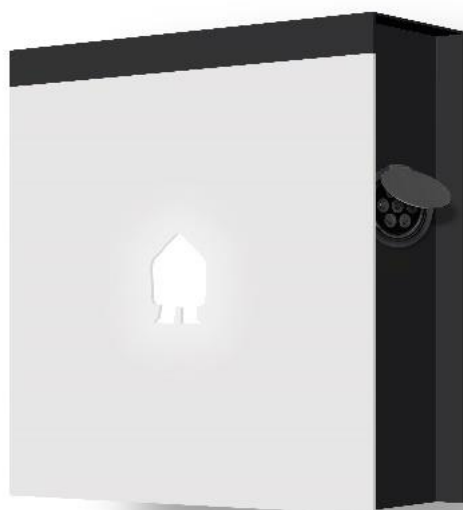

Document Accuracy

The specifications and other information in this document were verified to be accurate and complete at the time of its publication. Due to ongoing product improvement, this information is subject to change at any time without prior notice. For the latest information, see our online documentation: <https://www.smappee.com/downloads>

Table of contents

1. Introduction	4
2. Safety instructions.....	5
3. Models	7
4. Components.....	8
5. Technical specifications.....	10
6. Preparing the installation	13
7. Installation and activation	16
8. Using the EV Wall Lite	25
Declaration of conformity	29

1. Introduction

Thank you for purchasing this Smappee EV Wall Lite charging station for electric vehicles for charging at home.

This installation and user manual tells you how to install and use the Smappee EV Wall Lite. We advise you to read the contents of this manual carefully, to ensure a safe and proper installation.

Support

Only qualified electricians or equivalent may install the Smappee EV Wall Lite. If you have any questions, please contact your service partner.

Please have the following information ready to speed up the process: article number and serial number which you can find on the identification label of the charging station.



Should your local distributor be unable to help you, or you have a suggestion for us, you can contact Smappee at: **support@smappee.com**.

Smappee n.v.
Evolis 104
8530 Harelbeke
Belgium

2. Safety instructions

Safety warning

Fully read and follow the safety instructions below before you install, service or use your Smappee EV Wall Lite. The installer must ensure that the charging station is installed in accordance with the relevant national and local regulations.

Carrying out activities on this charging station without the relevant knowledge and qualifications can lead to serious accidents and death. Only carry out tasks for which you are qualified and have been fully instructed.

Incorrect installation, repairs or modifications can result in danger to the user and may void the warranty and liability.

Safety precautions

	CAUTION: Risk of electric shock.
	CAUTION: Refer to the accompanying documentation whenever you see this symbol.

Please observe the following safety precautions to avoid potential electric shock, fire, or personal injury:

- The charging station is intended exclusively for charging electric vehicles and, when installed correctly, may be used by untrained individuals.
- Switch off electrical power supply to your charging station before installation or maintenance work.
- Do not use the charging station if damaged / defective.
- Do not immerse the charging station in water or any other liquids.
- Do not expose the charging station to heat, flame or extreme cold.
- Do not attempt to open, repair, or service any parts. Contact Smappee or your service partner for further information.
- Only use the charging station under the specified operating conditions.
- Do not allow children to operate a charging station.
- When a charging station is in use, adult supervision of any children present is required.
- While charging the charging cable must be completely unwound and connected to the electric car without overlapping loops. This to avoid the risk of overheating the charging cable.

Maintenance

- Observe the maintenance schedule.
- Clean the outside only with a dry, clean cloth.
- Do not use abrasive agents or solvents.
- May not be carried out during rain or if air humidity exceeds 95%.

Keeping order

- After charging store the charging cable properly so it does not present a tripping hazard.
- Make sure the charging cable cannot become damaged (kinked, compressed or driven over).
- Do not place any objects on the charging station.

Transport and storage

- Disconnect electrical power supply before removing the charging station for storage or relocation.
- Only transport and store the charging station in its original packaging. No liability for damage incurred will be accepted if the charging station is transported in non-standard packaging.
- Store the charging station in a dry environment within the temperature range specified in the technical specifications.

3. Models

Article no.	EAN	Description
EVWL-332-BR-E-W	5425036933989	EV Wall Lite White 3-Phase 22 kW Socket
EVWL-332-BSR-E-W	5425036933996	EV Wall Lite White 3-Phase 22 kW Socket with shutter

4. Components

Components included



EV Wall Lite

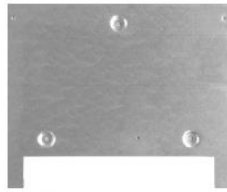

EV Wall mounting plate



Screw & plug



Small screw



QR code sticker



Smart Charge Card



Quick Install Guide



Quick Starter Guide

Identification label

The identification label of your charging station is located on the left inner side of the EV Wall Lite.

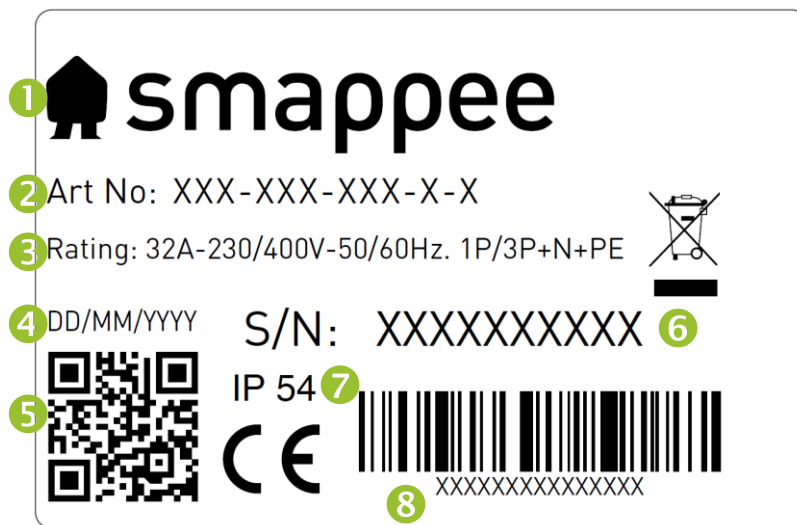

1. Manufacturer
2. Article number
3. Rating
4. Manufacturing date
5. QR code containing article number and serial number
6. Serial number
7. Degree of protection
8. EAN code

5. Technical specifications

Feature	Description
Technical features	
Charging capacity	Single or triple phase, 7.4 to 22 kW
Output power	1-phase or 3-phase, 230 V – 400 V, 32 A
Charge mode	Mode 3 (IEC 61851)
Connection case	1 x Case B (Socket type 2)
Metering	kWh meter compliant with IEC 62053-21
Integrated Residual Current Protection	Rated operating residual current detection: 6 mA DC.
Supported power systems	TN-C, TN-C-S, TT, IT* * Caution: not all vehicles support the IT system. In this case or with 3x230V charging, a voltage transformer may be required.
Grounding	TN system: PE wire TT system: Independently installed ground electrode < 100 Ohm spreading resistance IT system: connected to a shared reference (common earth) with other metal parts
Rated voltage (U_n)	230 V – 400 V
Rated insulation voltage (U_i) of a circuit	500 V
Rated impulse withstand voltage (U_{imp})	4 kV
Rated frequency (f_n)	50 Hz / 60 Hz
Rated current (I_{na})	32 A
Rated current (I_{nc}) of a circuit	32 A
EMC classification	Class B
Connection method	AC, permanently connected
Required external protection	2P (single-phase) or 4P (three-phase) breaker of max. 32 A, type B or C 30 mA AC RCD type A or B (according to local regulations)
Interfaces & Connectivity	
Information status	RGB LED
Session activation	Plug and charge, Scan QR code, Swipe RFID card
Connectivity	Ethernet 100BASE-T, Wi-Fi 2.4 Ghz
Communication protocol	OCPP 1.6 JSON, ready for update to OCPP 2.0

Certifications and Standards	
Product certification	CE
Standards	IEC 61851-1 (2017)
Environment	
Enclosure material	Magnelis (housing), aluminium (front plate)
Enclosure standard colours	RAL9016 (star white) + RAL7021 (black grey)
Protection degree	IP 54
Mechanical impact protection	IK10
Pollution degree	3
Electrical safety class	I
Stand-by use	LED brightness 0%: 2 W LED brightness 100%: 5 W
Environmental conditions	Indoor and outdoor use
Operating temperature	-25 °C to 40 °C
Storage temperature	-25 °C to 60 °C
Relative humidity	0 % – 95 %, non-condensing
Maximum installation altitude	0 – 2.000 m
Access	Locations with restricted and non-restricted access
Physical properties	
Dimensions	300 x 300 x 110 mm
Weight (excluding packaging)	6.2 kg
Charging cable length	N/A
Supply line connection	Terminal block, flexible conductors up to 6 mm ² or solid conductors up to 10 mm ²
Stationary / moveable	Fixed installation
External design	Enclosed assembly
Mounting method	Wall

	<p>The operating temperature assumes the ambient temperature of a product delivered in the default enclosure colours RAL9016 (star white) + RAL7021 (black grey). Direct exposure to sunlight may have an adverse effect on the temperature range.</p>
	<p>If the product is exposed to lower or higher ambient temperatures, continuous operation cannot be guaranteed. If temperatures exceed the maximum values, the charging station will automatically decrease the charging current to decrease the internal temperature of the charging station.</p> <p>This stabilises the internal temperature and makes it less likely that a charging session will be unexpectedly paused.</p>
	<p>If the product is directly exposed to sunlight, the automated temperature management may automatically start below the maximum ambient temperature. Therefore, wherever possible, avoid exposing the charging station to direct sunlight.</p>
	<p>Where products are exposed to the elements of nature, the enclosure can be subject to gradual aging of the material, which can result in product discolouration over time. Therefore, wherever possible, place the product in a sheltered place to optimise the life of the materials.</p>

6. Preparing the installation

The first step is to prepare the physical installation of the EV Wall Lite as described in this chapter.

Installation prerequisites

- Calculate the existing electrical load to find the maximum operating current for the charging station installation. The Smappee EV Wall Lite is equipped with 1 connector which needs to be powered.
- Obtain all necessary permits from the relevant local authority.
- Refer to local wiring regulations to select the conductor sizes and use only copper conductors.
- Make sure that the installation area of the charging station is adequate for usability and ventilation purposes.
- Use the correct tools and provide sufficient material resources and protection measures.

Power supply

- The appropriate wire gauge of the supply cable depends on the power rating and distance between the meter cabinet and the charging station. The voltage drop must not exceed 5%. It is advisable to have a maximum voltage drop of 3 %.
- The maximum wire gauge that can be fitted is 6 mm² in case of flexible conductors or 10 mm² when solid conductors are used.
- The power supply must be protected against short-circuiting and over-current with an individual B or C circuit breaker with a current rating of maximum 32 A (or otherwise in compliance with local standards and regulations). An RCD of type A or B (according to local regulations) with rated residual operating current of 30 mA must also be installed. A charging station connector must always be installed on a dedicated power circuit.
- When the power supply and the charging station are part of a TN-S system, the station must be grounded via the main distributor.
- Route the power supply cables to the position where the charging station will be installed together with an Ethernet cable for the internet connection (if applicable).
- Make sure that there is at least 30 cm cable available at the location of the EV Wall Lite to be able to connect it easily internally.
- Local regulations may be applicable and can vary depending upon the region or country.



The power supply enters the station at the bottom of the housing through the middle cable gland.

The Cat 5/6 Ethernet cable also enters the charging station via the bottom of the housing. Ensure that you attach the RJ-45 connector only **after** inserting the cable into the EV Wall Lite housing.

The maximum power rating for each connector is specified in the table below.

Power per connector	Connection	Input current	Output current
7.4 kW	1-phase	1 x 32 A	1 x 32 A
22 kW	3-phase	3 x 32 A	3 x 32 A

Route Ethernet cable

The EV Wall Lite requires a stable internet connection via Ethernet. An RJ-45 connector (not supplied) should be attached to the end of the cable. Only attach the RJ-45 connector **after** inserting the cable into the housing. The RJ-45 connector will not fit through the EV Wall Lite cable gland!

Prepare the mounting

The Smappee EV Wall Lite is designed to be mounted on a wall.

When positioning the EV Wall Lite, take into account that the power supply cables and Ethernet cable are entering the housing at the bottom through cable glands. The central M32 cable gland is for the power supply, the M20 cable gland for the Ethernet cable.

Tools (not included)

- Screwdrivers
- 3mm Hex screwdriver
- 7mm socket wrench with extension bar
- Multimeter and earth ground meter
- Wire stripper and cutter
- Needle-nose pliers
- Ferrules crimper, for stranded power supply cables
- Drill and rock drill diameter 10 mm
- Hammer
- RJ45 crimping tool

Supplies (included)

- 3 x wall plugs and screws (\varnothing 4.8 mm x 50 mm)
- 3 x M4 x 6 mm HEX screws

Supplies (not included)

- CAT 5/6 ethernet cable and RJ45 connector for internet access
- Power supply cables
- Ferrules (6 mm²), for stranded power supply cables
- 32 A circuit breaker
- 30 mA RCD Type A or B

7. Installation and activation

This procedure describes the required steps for the physical installation of the EV Wall Lite.

	CAUTION: Make sure it is not possible to connect the electric current during installation. Put up caution tape and warning signs to mark the work areas. Make sure no unauthorised people can enter the work areas.
	CAUTION: The electric system must be entirely disconnected from every power source prior to performing installation or maintenance work. Make sure it is not possible to connect the electric current during installation. Put up caution tape and warning signs to mark the work areas. Make sure no unauthorised people can enter the work areas.
	CAUTION: The charging station contains electric components that may still contain electrical charge after being disconnected. Wait at least 10 seconds after disconnection before commencing work.
	CAUTION: Adaptors or conversion adaptors and cord extension sets are not allowed to be used.

Place the mounting plate in position

- Use the mounting plate to mark the position of the screws on the wall where the EV Wall Lite is to be positioned.
- Make sure the mounting plate is positioned with the 2 insert holes on the bottom and that it hangs level.
- Drill 3 holes of 10 mm diameter through the slots to a depth of 50 mm. Insert the supplied wall plugs into the holes.
- Attach the mounting plate, with the 3 bulges facing the wall, to the wall with the supplied screws, as depicted below.

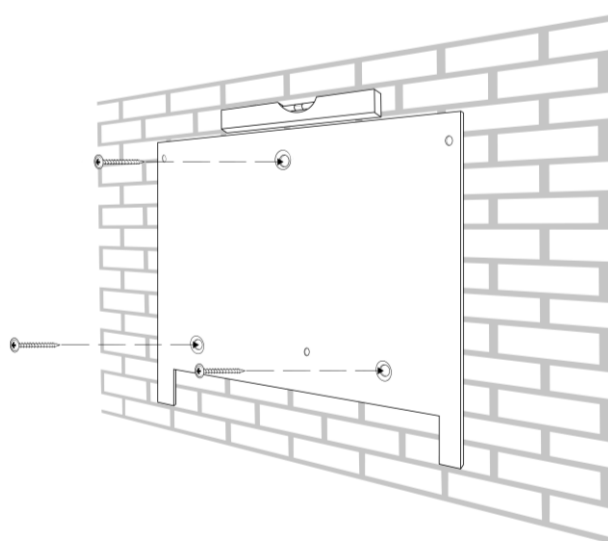

Place the EV Wall Lite in position

- a. Untighten the two M4 nuts on the back of the front plate and remove the front plate of the EV Wall Lite. Safely put aside the front plate to avoid damaging the PCB-board attached to it.

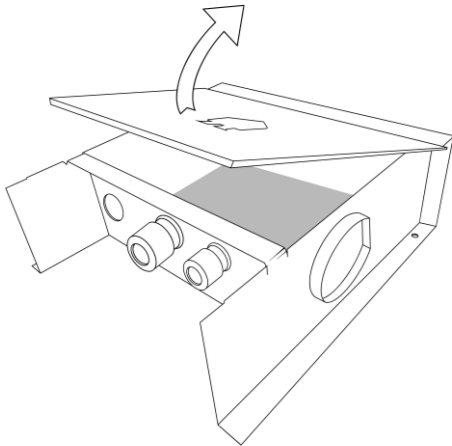

- b. Attach the EV Wall Lite housing to the mounting plate using the three supplied M4 x 6 mm HEX screws.

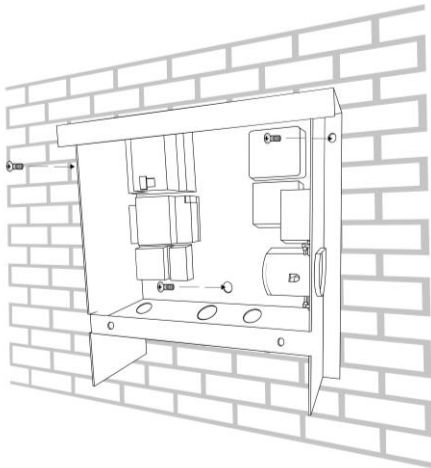

Power supply connection

- a. Slide the power cable through the middle cable gland.
- b. Cut the power supply cables to adequate length and add the ferrules to each conductor if stranded cables are used.
- c. Measure the resistance of the grounding circuit and make sure that it is within acceptable limits. If necessary, install a grounding point closer to the charging station.
- d. Connect each power supply cable to the terminal block.
If you have a single-phase power supply, only the L1, N and PE wires are connected.

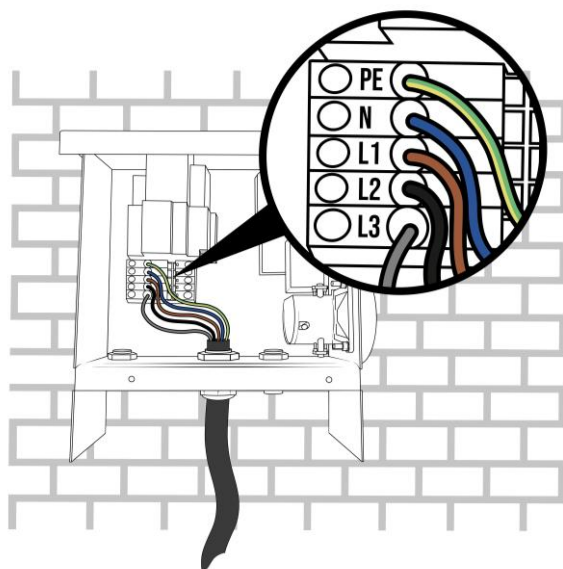

IMPORTANT notes for 3P (3 x 230 V) – Delta topology



This section is only relevant if you have a delta grid topology. This is only found in some parts of Belgium and Norway. If this is not applicable, you can skip this section.

When an EV Wall Lite is installed in a residential installation with a 3P (3 x 230 V) Delta grid connection, some additional requirements need to be taken into account. You can verify whether you have this topology by checking the grid connection to see if the following are true:

- There is no neutral wire.
- The voltage between two phases is approximately 230 V.
- The voltage between a phase and earth is approximately 130 V.

Some EVs are not compatible with this type of grid connection due to a built-in security in the EV. Contact your EV manufacturer for more information.

The security feature that some EVs have is a voltage check between the phase that is connected as neutral and the ground. If this is not 0 volts, the car won't charge. The presence of this security feature may vary for each manufacturer and for each model.

As there is no neutral wire available in this topology, the L3 will be used as neutral. In this case, some EVs will be able to charge dual phase (using both L1 and L2) and some will only charge single phase. In practice, this may limit the maximum charging power. This again varies for each EV manufacturer and each model.

If your EV is not compatible with this grid topology, or if you would like to achieve higher charging power than what is possible on a delta grid topology, you can install a transformer. This transformer will convert the 3 x 230 V delta topology to a standard 3 x 400 V + N star topology.

Without transformer

If you are connecting the charging station directly to the 3 x 230 V delta grid, without transformer, please refer to the diagrams below.

As depicted, the L3 connector is left empty. The L3 power supply cable is connected to the N connector block.

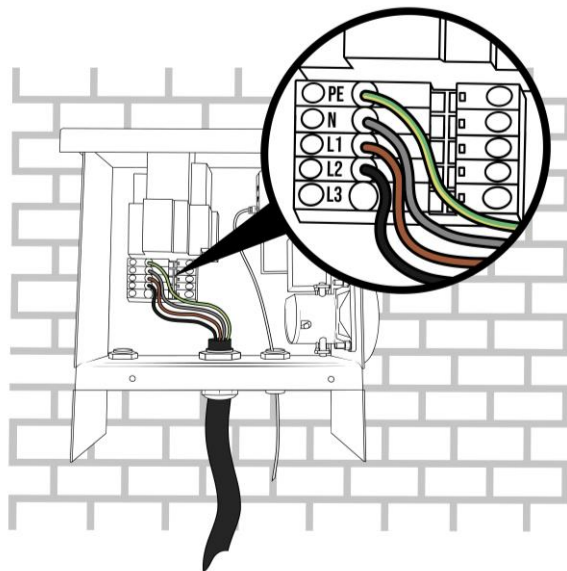

We highly recommend that you test compatibility with the customer's EV during installation. If you have connected the EV Wall Lite as shown above but the EV will not charge, you can try to disconnect the L2 cable going to the socket. Do not disconnect the L2 of the power supply cable!

With transformer

If a transformer is used to convert the 3 x 230 V delta connection to a standard 3 x 400 V star with neutral, then the charging station's power supply can be connected as usual. Please refer to the pictures on previous pages for this.

Closure

- a. Attach an RJ45 connector to the Ethernet cable after feeding it through the right cable gland. Plug it into the Smappee Connect.

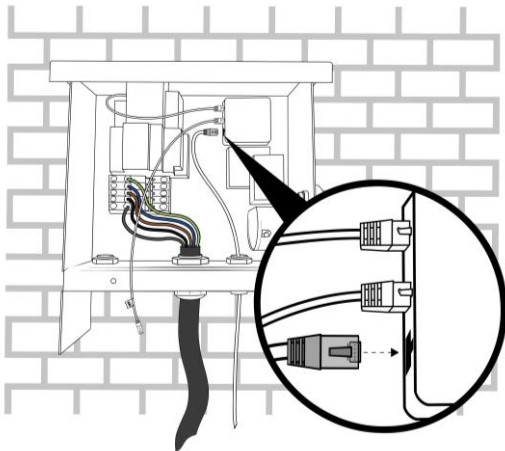

As an optional setup, it is possible to remove the Connect from the EV Wall Lite and mount it inside of the building. See “Optional: mount the Connect inside of the building” for more information

- b. Mount the front plate into position by connecting the RJ10 cable to one of the B ports of the PCB attached to the front plate.

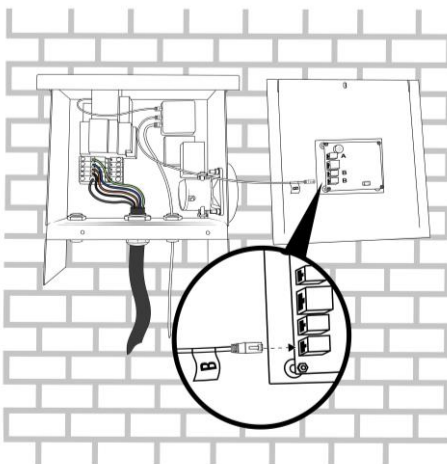

Be careful to connect the RJ10 cable to one of the **B** ports. Do not connect it to the A port.

The Ethernet cable should be connected to the Smappee Connect, **not** to the PCB attached to the front plate.

- c. Mount and tighten the supplied M4 nuts.

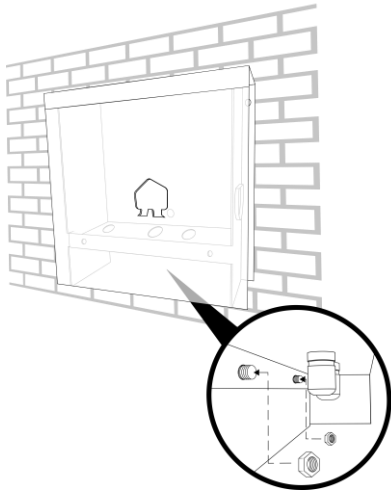

Optional: mount the Connect inside of the building

In some rare occasions, it might be beneficial that the Snappee Connect is removed from the EV Wall Lite and mounted inside of the building.

This might be an option when the owner is concerned about the security of the Internet connection and doesn't want an Ethernet cable to leave the building.

A second reason might be that the owner opts for a Wi-Fi internet connection and the signal is not strong enough to reach the EV Wall Lite.

It is possible to remove the Connect from the EV Wall Lite and mount it inside of the building.



This kind of setup requires some additional components, which are not included.

Below you find the schematic overview on how this alternative installation can be accomplished.

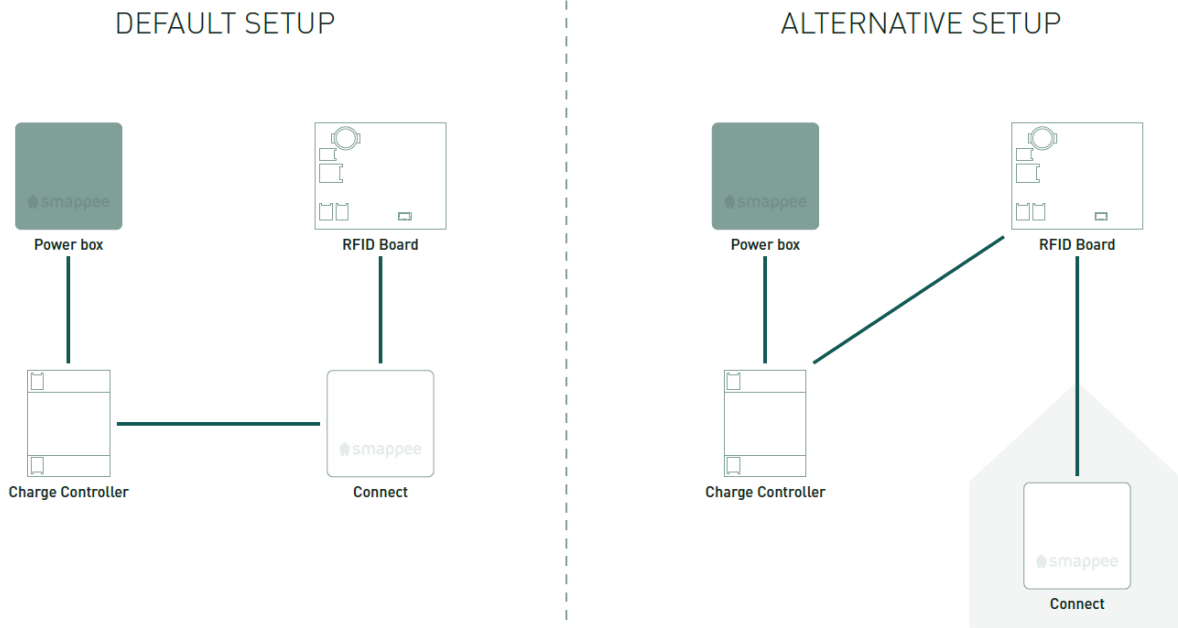

Follow the steps below to make the correct interconnections between all components.

- a. Remove the RJ-10 data cable from the Connect.
- b. Mount the Connect in the desired location. To accomplish this, an extra DIN mounting plate or wall mounting plate is necessary (not included).
- c. Route an Ethernet cable for internet connection to the Connect. Connect the Ethernet cable to the RJ-45 port of the Connect (not included).
- d. Route an RJ-10 data cable from the Connect to the EV Wall Lite. Connect the data cable to one of the B-ports of the Connect (not included).
- e. Route the RJ-10 data cable through the right cable gland.
- f. Connect the new RJ-10 data cable and the data cable coming from the charge controller to the B-ports of the PCB on the front plate.

Switching on the EV Wall Lite

- a. Check all connections are secure and power-up the EV Wall Lite.
- b. Check the status LEDs:
 - Charging controller: green flashing light (1 x per 3 seconds)
 - RCM: continuous green light
 - Smappee Connect: blue flashing
 - Power Box: green flashing light (1 x per 3 seconds)

Activation

This procedure is done with the Smappee mobile app. You can download this from the Apple App Store for iOS or the Google Play store for Android phones.



The Smappee App will guide you through the various steps to fill in all the required information.

- Log in to the Smappee App with the given Smappee username or create a new user account.
- Install a Smappee car charging station.
- Follow the steps shown in the mobile app.



The settings of your charging station can be adjusted in the Smappee Mobile app or Dashboard.

- Smappee Mobile App: Name, Maximum current per connector, Charging speed and LED brightness
- Dashboard: Name, Maximum current per connector, charging speed and LED brightness

8. Using the EV Wall Lite

There are three ways of charging using a Smappee EV Wall Lite:

1. Plug and charge: Simply connect your cable and start charging.
2. Swipe and charge: Connect the cable, swipe your card and start charging.
3. Scan and charge: Connect the cable, scan the QR code in the Smappee app and start charging.

Below you can find the different charging sequences.

	Each EV Wall Lite that is installed and activated is Plug and charge. Changing the Session Activation Method is done using the Smappee Dashboard. Changing the authentication methods can be done remotely.
	Scan and charge and Swipe and charge (with Smappee CPO) can only be used when a Smappee Payment Package has been signed. See this article for more info.

Plug and charge

The charging station is freely accessible without the need to authorize. Anyone can plug their car into the charger and start charging for free.

Start charging

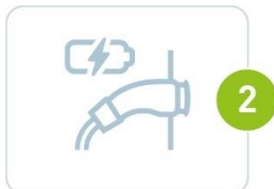

Stop charging

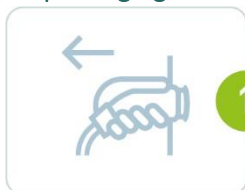

Swipe and charge

Charging sessions can be started using an RFID card. You can either use a Smappee Smart Charge Card for free charging or (if activated) a third party eMSP card to pay for charging sessions.

The RFID reader is found on the front plate of the EV Wall Lite, together with the ambient light.

- **Whitelist:** charging is free with a Smappee Smart Charge Card or any other authorized RFID card. Once the charging cable is plugged-in, the user simply swipes their RFID card and the free charging session begins. All authorized cards must first be added to the whitelist using the 'Whitelisting' card on dashboard.smappee.net. See [this](#) article for more information. Cards can be ordered via the Smappee dashboard.
- **Public charging:** Other EV drivers can use this charging station and pay with an RFID card / token from a third-party eMSP. This can be done through Smappee's own CPO or through a third-party CPO. Public charging is activated using the Smappee dashboard. See the [Smappee Academy](#) for more information.
- **Split Billing:** This is aimed at employees who charge their company car at home and need to be reimbursed for the electricity consumption. Split billing agreements must be made for each employee. Starting a charging session is similar to whitelisting but at the end of each month, Smappee Services will send a bill for all employees' charging sessions to the company. All individual employees will be reimbursed according to the amount of kWh charged. Split billing is activated using the Smappee dashboard. See [this](#) article or the [Smappee Academy](#) for more information.

Start charging



Stop charging



Scan and charge

The user pays by credit card (Visa or Mastercard) using the Smappee app. They scan the QR code shown on the charging station and the app will guide them through the process of starting the charging session. It is also possible to set discount rates for specific users. Scan and charge is activated using the Smappee dashboard. See the [Smappee Academy](#) for more information.

Start charging

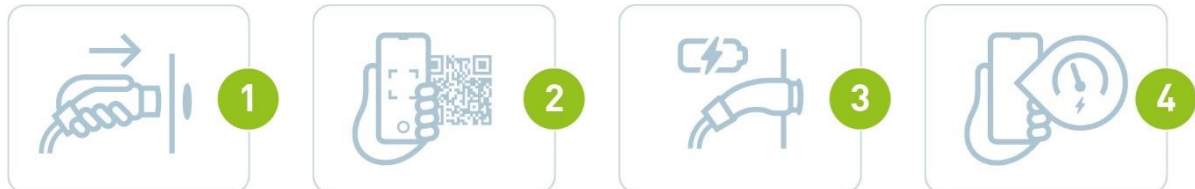







Stop charging



More information on how to use the Smappee EV Wall Lite can be found on:
support.smappee.com/hc > Smappee EV Line

LED status

LED colour	LED status	Meaning	Action of the user
	White continuous	The Smappee EV Wall Lite is available.	Connect your EV with the Smappee EV Wall Lite.
	Blue continuous	Your EV is connected with the Smappee EV Wall Lite, but is not yet charging.	<ul style="list-style-type: none"> • If using an RFID, swipe your charge card at the Smappee sign and wait until the LED turns flashing blue. • If using QR codes, scan the QR code and wait until the LED is green pulsing. • If no authorisation is required, wait until the LED becomes green pulsing.
	Blue flashing	Your RFID card is being verified.	Wait until the LED is green pulsing.
	Green pulsing	The Smappee EV Wall Lite is charging your EV.	Your EV is being charged.
	Green continuous	The EV is now fully charged.	Disconnect the cable.
	Red continuous	The Smappee EV Wall Lite is unavailable.	Check the manual or contact your supplier for more info and further steps.
	Red flashing	Your charge card is not authorised.	Contact your charge card supplier.

Declaration of conformity

We,

Smappee nv
Evolis 104
B-8530 Harelbeke
Belgium

following the provision of the following EC Directives:

- 2014/35/EU The Low Voltage Directive
- 2014/30/EU The Electromagnetic Compatibility Directive
- 2011/65/EU RoHS Directive

hereby declare that the product:

EVWL-332-BR-E-W, EVWL-332-BSR-E-W

is in conformity with the applicable requirements of the following documents

- * Emissions:
(EN61326-1 : 2013)
Radiated Emission: EN 55011:2009 / EN 55032:2015 (Class B)
Conducted Emission: EN 55011:2009 / EN 55032:2015 (Class B)
Harmonic current Emission: EN 61000-3-2:2005 +A1:2008 + A2:2009
Flicker: EN 61000-3-3:2008
- * Immunity:
(EN61326-1 : 2013)
ESD : EN 61000-4-2:2008 / EN 61000-4-2 :2009
Radiated immunity : EN 61000-4-3:2006 + A1:2007 + A2: 2010
Power frequency magnetic field: EN 61000-4-8:2009
Voltage dips/interruptions: EN 61000-4-11:2004
Common Mode Immunity: EN 61000-4-6:2008 / EN 61000-4-6:2009
Burst : EN 61000-4-4:2004 / EN 61000-4-4:2012
Surge: EN 61000-4-5:2005 / EN 61000-4-5:2006
- * Safety:
Metering Function : IEC 61010-1 Ed 3.0 (2010-06) + A1:2016
AC Charging equipment : IEC 61851-1 (2017) / EN61558-1
- * Other applicable standards and certifications: IEC 60364, IEC 62192-1, IEC 62192-2

Harelbeke, Belgium, January 13, 2023

Authorized signatory



Stefan Grosjean
CEO