

# Smappee EV One Home Installation manual



**Document accuracy**

The specifications and other information in this document were verified to be accurate and complete at the time of its publication. Due to ongoing product improvement, this information is subject to change at any time without prior notice. For the latest information, see our online documentation: [smappee.com/downloads](https://smappee.com/downloads)

# Table of contents

1	Introduction.....	4
2	Safety instructions.....	5
3	Overview of the EV One Home.....	7
4	Preparing the installation.....	14
5	Installation and activation.....	23
	Annexes.....	34

# 1 Introduction

Thank you for purchasing this EV One charging station for electric vehicles, the smartest charging station.

This installation manual tells you how to install the EV One Home. We recommend that you read the contents of this manual carefully, to ensure a safe and proper installation and enable to use all the advanced features of this product to the full.

## Intended use

This charging station is designed for charging electric vehicles using a compatible Type 2 charging cable connected to the socket outlet. The use of intermediate adapters or extension cables is not permitted.

Use for any other purpose than EV charging as defined in the IEC 61851-series is not and constitutes misuse of the charging station. Only qualified, trained and authorised persons are allowed to install, maintain and/or repair the charging station and make sure that the technical specifications and installation requirements are met. Incorrect installation and testing of the charging station could potentially damage either the vehicle's battery or the device. Any resulting damage is excluded from the warranty of the device. Any modification that is not in writing confirmed by Smappee will void the warranty. For more information, refer to [smappee.com/legal-documents](https://smappee.com/legal-documents).

## Support

Only qualified electricians or equivalent may install the charging station. If you have any questions, please contact your service partner.

Please have the following information ready to hand to speed up the process: Article number and serial number which you can find on the identification label of the charging station.





Should your local distributor be unable to help you, or you have a suggestion for us, you can contact Smappee at: [support@smappee.com](mailto:support@smappee.com).

Smappee NV  
Evolis 104  
8530 Harelbeke  
Belgium

# 2 Safety instructions

## 2.1 Safety warnings and precautions

	<p><b>WARNING</b></p> <p>Carrying out activities on this charging station without the relevant knowledge and qualifications can lead to serious accidents and death. Only carry out tasks for which you are qualified and have been fully instructed.</p> <p>Only certified electricians may carry out the installation, which must be in accordance with the national safety regulations.</p> <p>Fully read and follow the safety instructions below before you install, service or use your EV One. Incorrect installation, repairs or modifications can result in danger to the user and may void the warranty and liability.</p>
	<p><b>CAUTION</b></p> <p>Risk of electric shock.</p> <p>Refer to the accompanying documentation whenever you see this symbol.</p>

Please observe the following safety precautions to avoid potential electric shock, fire, or personal injury:

- Use the correct tools and provide sufficient material resources and protection measures.
- The charging station is, when installed correctly, intended to be used by untrained individuals to exclusively charge their electric vehicle.
- Do not allow children to operate a charging station.
- When a charging station is in use, adult supervision of any children present is required.
- Switch off electrical power supply to your charging station before installation or maintenance work.
- Do not use the charging station if it is damaged or defective.
- Do not immerse the charging station in water or any other liquids.
- Do not expose the charging station to heat, flame or extreme cold.
- Do not attempt to open, repair, or service any parts. Contact Smappee or your service partner for further information.
- Only use the charging station under the specified operating conditions.
- While charging the charging cable must be completely unwound and connected to the electric car without overlapping loops. This to avoid the risk of overheating the charging cable.
- After charging store the charging cable properly so it does not present a tripping hazard. Make sure the charging cable cannot become damaged (kinked, compressed or driven over).
- Do not place any objects on the charging station.

## **2.2 Maintenance**

- Observe the maintenance schedule (page 43).
- Clean the outside only with a dry, clean cloth.
- Do not use abrasive agents or solvents.
- May not be carried out during rain or if air humidity exceeds 95 %.

## **2.3 Transport and storage**

- Disconnect electrical power supply before removing the charging station for storage or relocation.
- Only transport and store the charging station in its original packaging. No liability for damage incurred will be accepted if the charging station is transported in non-standard packaging.
- Store the charging station in a dry environment within the temperature range specified in the technical specifications.

# 3 Overview of the EV One Home

## 3.1 Models

### Charging station

<b>Article no.</b>	<b>EAN</b>	<b>Description</b>
EVO-332-B-E-B	5425036934054	EV One Home 3-Phase 22 kW

### Accessories (not included)

<b>Article no.</b>	<b>EAN</b>	<b>Description</b>
FLOOR-PLATE-TUBE120	5425036934719	Floor plate for EV One or Pay Station 120 mm x 120 mm

## 3.2 What's in the box

In the EV One box is an Accessory Box, that has different items related to the measurement in the distribution panel and communication of the data with the Smappee Cloud.

### EV One box

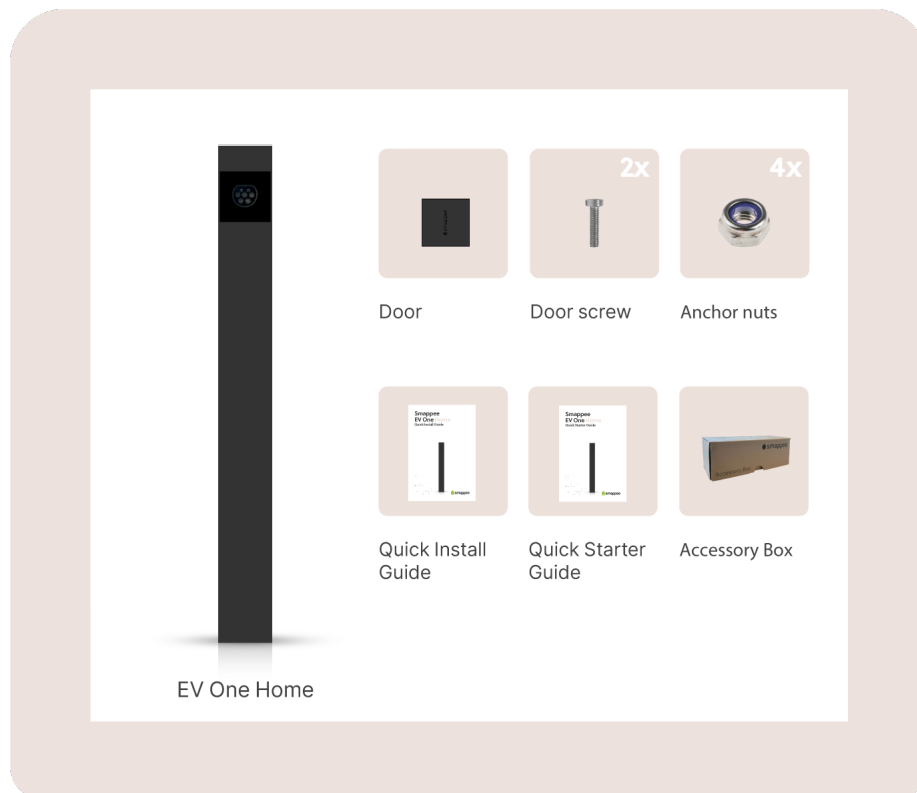

Image 1: Content of the box with the charger

Quantity	Description
1	EV One Home, including anchor components
1	Door
2	Door screw
4	Nuts for the anchor
1	Quick Install Guide
1	Quick Starter Guide, including Smart Charge card and QR code for Scan and charge
1	Accessory Box, refer to the following topic

## Accessory Box



Image 2: Content of the box with the accessories

Quantity	Description
1	Smappee Splitter
1	DIN mounting plate
1	Smappee Connect
1	Wall mounting plate
1	Bus termination plug
1	CT Hub
1	Solid Core 3-Phase CT
4	CT 50A
1	RJ10 cable 150 cm
2	RJ10 cable 40 cm

### 3.3 Directional determination

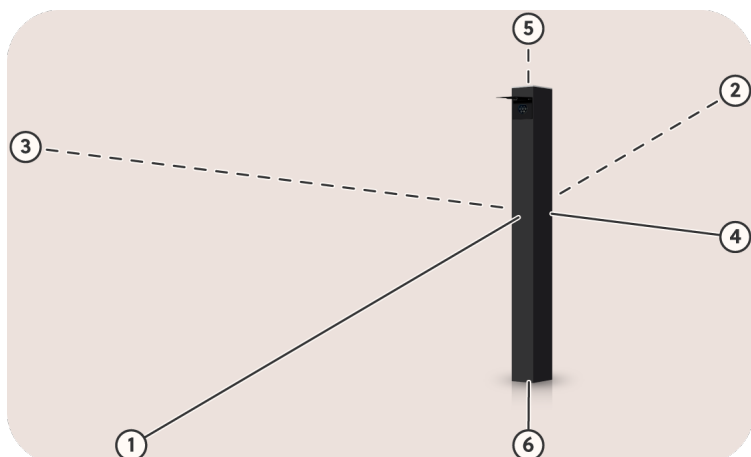

Image 3: Directional determination

<b>Id</b>	<b>Description</b>
1	Front
2	Rear
3	Left
4	Right
5	Top
6	Bottom

### 3.4 Identification label of the EV One

#### Position of the identification label of the EV One

The identification label of your charging station is located on the rear of the door.

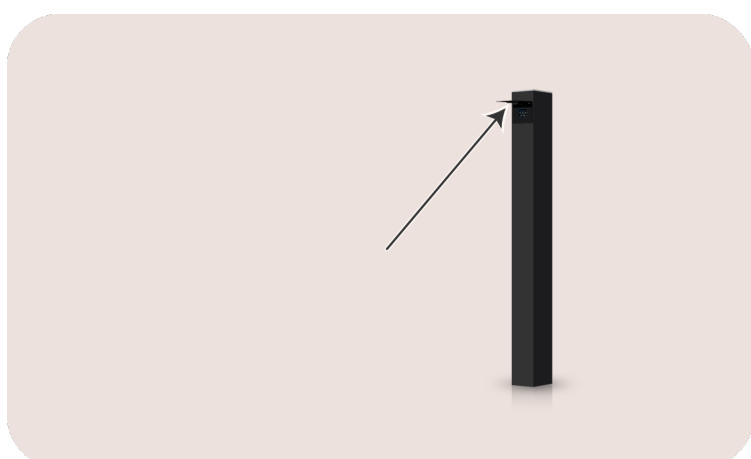

Image 4: Position of the identification label

## Identification label of the EV One

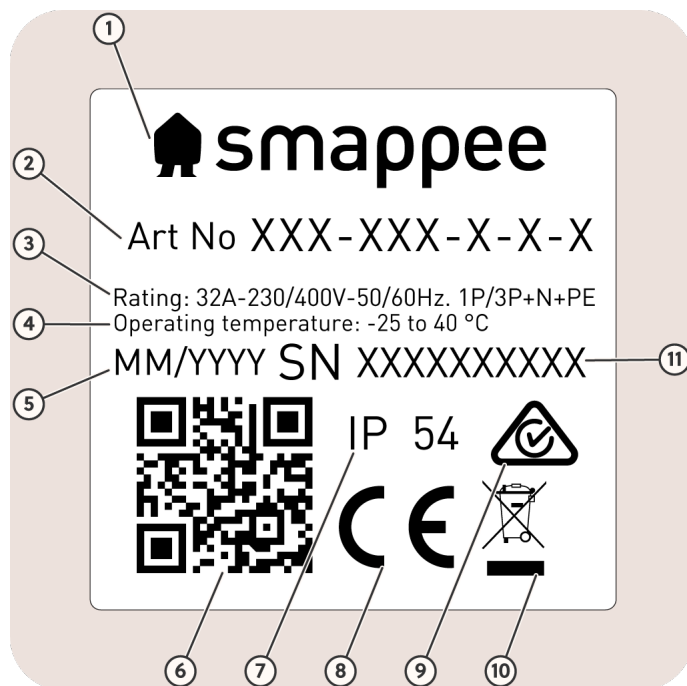

Image 5: Identification label

No.	Description
1	Manufacturer
2	Article number
3	Rating
4	Operating temperature
5	Manufacturing date
6	QR code to scan during configuration of the charging station
7	Ingress protection rating
8	CE
9	RCM
10	Waste disposal symbol
11	Serial number

### 3.5 Technical specifications

Feature	Description
<b>Physical properties</b>	
Dimensions	1100 mm x 120 mm x 120 mm
Weight (excluding packaging)	12.3 kg
Socket	All variants manufactured as of September 13, 2024, have a type 2 socket with shutter.
Charging cable	N/A
Supply line connection	Flexible conductors up to 6 mm <sup>2</sup> or solid conductors up to 10 mm <sup>2</sup>
Stationary / moveable	Fixed installation
External design	Enclosed assembly
Mounting method	Ground mounted
<b>Technical features</b>	
Output power	Single-phase connection: maximum 7.4 kVA Three-phase connection: maximum 22 kVA
Charge mode	Mode 3 (IEC 61851)
Connection case	Case A and B (Socket) (IEC 61851)
Metering	kWh meter compliant with IEC 62053-21 and accuracy of 1%
Integrated Residual Current Protection	Rated operating residual current detection: 6 mA DC and 30 mA AC RCD type A
Supported power systems	TN-C, TN-C-S, TT, IT <sup>1</sup>
Grounding	TN system: PE wire TT system: Independently installed ground electrode < 100 Ohm spreading resistance IT system: connected to a shared reference (common earth) with other metal parts
Rated voltage (U <sub>N</sub> )	230/400 VAC
Rated insulation voltage (U <sub>i</sub> ) of a circuit	500 V
Rated impulse withstand voltage (U <sub>imp</sub> )	4 kV
Rated frequency (f <sub>N</sub> )	50 Hz / 60 Hz
Rated current (I <sub>na</sub> )	32 A
Rated current (I <sub>nc</sub> ) of a circuit	32 A
Rated peak withstand current (I <sub>pk</sub> )	6 kA
Rated conditional short-circuit current (I <sub>cc</sub> )	6 kA
EMC classification	Class B

<sup>1</sup> Caution: not all electric vehicles support the IT system. For 3 x 230 V charging, a voltage transformer might be necessary.

Connection method	AC, permanently connected
Required external circuit breaker(s)	1 x 2P (single-phase), 1 x 3P (three-phase) or 1 x 4P (three-phase with neutral) breaker of max. 40 A, type B or C
<b>Interfaces &amp; Connectivity</b>	
Information status	RGB LED
Session activation	Plug and charge, Swipe RFID, Scan QR code
Connectivity	Ethernet 100BASE-T, Wi-Fi 2.4 GHz
Communication protocol	OCPP 1.6 JSON, ready for update to OCPP 2.0
<b>Certifications and Standards</b>	
Product certification	CE, ACMA
Standards	IEC 61851-1 (2017), AS/NZS 3820:2020
<b>Environment</b>	
Enclosure material	Magnelis (structure), aluminium (housing)
Enclosure standard colours	RAL 7021 (black grey)
Protection degree	IP 54
Mechanical impact protection	IK10
Pollution degree	3
Electrical safety class	I
Stand-by use	LED brightness 0%: 2 W LED brightness 100%: 5 W
Environmental conditions	Indoor and outdoor use
Operating temperature	-25 °C to 40 °C
Storage temperature	-25 °C to 60 °C
Relative humidity	0 % - 95 %, non-condensing
Maximum installation altitude	0 – 2000 m
Access	Locations with restricted and non-restricted access

#### NOTE



- The operating temperature assumes the ambient temperature of a product delivered in the default enclosure colour RAL 7021 (black grey). Direct exposure to sunlight may have an adverse effect on the temperature range.
- If the product is exposed to lower or higher ambient temperatures, continuous operation cannot be guaranteed. If temperatures exceed the maximum values, the charging station will automatically decrease the charging current to decrease the internal temperature of the charging station. This stabilises the internal temperature and makes it less likely that a charging session will be unexpectedly paused.
- If the product is directly exposed to sunlight, the automated temperature management may automatically start below the maximum ambient temperature. Therefore, wherever possible, avoid exposing the charging station to direct sunlight.
- Where products are exposed to the elements of nature, the enclosure can be subject to gradual aging of the material, which can result in product discolouration over time. Therefore, wherever possible, place the product in a sheltered place to optimise the life of the materials.

# 4 Preparing the installation

The first step is to prepare the physical installation of the EV One Home as described in this chapter.

## 4.1 Installation prerequisites

- Obtain all necessary permits from the relevant local authorities.
- Local regulations may be applicable and can vary depending upon the region or country.
- Make sure that there is sufficient space around the charging station as specified in the IEC 60204-1 standard.
- Make sure that the installation area of the charging station is adequate for usability and ventilation purposes.
- Refer to local wiring regulations to select the conductor sizes and use only copper conductors.
- Calculate the existing electrical load to find the maximum operating current for the charging station installation.
- The appropriate wire gauge of the supply cable depends on the power rating and distance between the meter cabinet and the charging station. The voltage drop must not exceed 5 %. It is advisable to have a maximum voltage drop of 3 %.
- The power supply connection must be protected against short-circuiting and over-current with an individual circuit breaker. This circuit breaker must be 2-pole (for single-phase), 3-pole (three-phase without neutral) or 4-pole (three-phase with neutral), curve B or C, and have a current rating of maximum 40 A (or otherwise in compliance with local standards and regulations).

	<p><b>NOTE</b></p> <p>Some EVs are not compatible with a 3 x 230 V grid due to a built-in security in the EV. Contact your EV manufacturer for more information. If your EV is not compatible with this grid topology, or if you would like to achieve higher charging power than what is possible on a delta grid topology, you can install a transformer that converts the 3 x 230 V topology to a standard 3 x 400 V + N topology.</p>
---	---

- Make sure that there is one network cable for the internet connection available for the EV One, if you prefer a wired internet connection.
- The EV One Home requires a communication cable between the EV One Home and the distribution panel where the CT measurements and Connect gateway are placed. To do this, four twisted pairs of a communication cable are used.
- Route the power supply cable and the communication cable, if applicable, to the position where the charging station will be installed.

	<p><b>NOTE</b></p> <p>Make sure that there is at least 100 cm power supply and 100 cm communication cable length available at the location of the EV One to be able to connect it easily.</p>
---	---

- Use the supplied anchor (page 17) or the optional floorplate (page 25) to attach the EV One.

## 4.2 Tools (not included)

- Torque wrench with extension bar and socket (inner hex 2.5 and 4 mm and screw width 8 mm)
- Multimeter and earth ground meter
- Wire stripper and cutter
- Needle-nose pliers
- Ferrules crimper (only for stranded power supply cables)
- RJ45 crimping tool
- Rock drill diameter 8 mm (only for floorplate)
- Hammer
- Screwdrivers

## 4.3 Supplies (not included)

- Power supply cable
- Circuit breaker for power supply
- Communication cable and RJ45 connectors, minimum Cat 5 depending on the environment
- Circuit breaker for Power Box (only for 3 x 230 V with transformer)
- Wi-Fi extender if the signal is weak or absent
- Network cable and RJ45 connectors, minimum Cat 5 depending on the environment, if using wired internet connection
- Ferrules, when using stranded power supply cables

## 4.4 Prepare the foundation of the EV One

### Context



#### NOTE

This section is only relevant if you use the optional floorplate to attach the EV One. If you use the anchor, go to Prepare the EV One (page 17).

A stable and level ground needs to be prepared in advance and there must be a power supply cable and a network cable. The surface of the ground must be solid to allow the usage of concrete anchors and avoid moisture from the soil.

We recommend a levelled concrete foundation at ground level. This can be a polished concrete floor in a parking garage or a flat surface for installation of the charging stations.

### Instructions

Proceed as follows.

1. Make a foundation hole large enough.  
Depending on the subsoil, the size may vary. Please refer to the technical specifications of size and weight to determine and construct a solid foundation for the EV One.  
When dimensioning the foundation, it is advisable to carry out a static load capacity analysis according to the relevant standards.

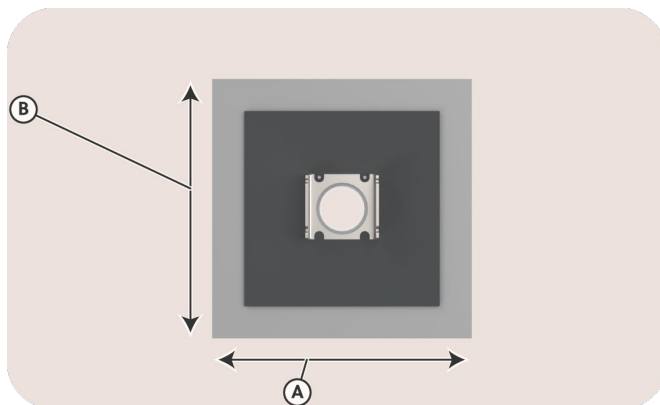

Image 6: View on the minimum dimensions ( $A \times B = 0.40 \text{ m} \times 0.40 \text{ m}$  or  $1.31 \text{ ft} \times 1.31 \text{ ft}$ )

2. Route the power supply cable and the network cable to the location of the EV One.

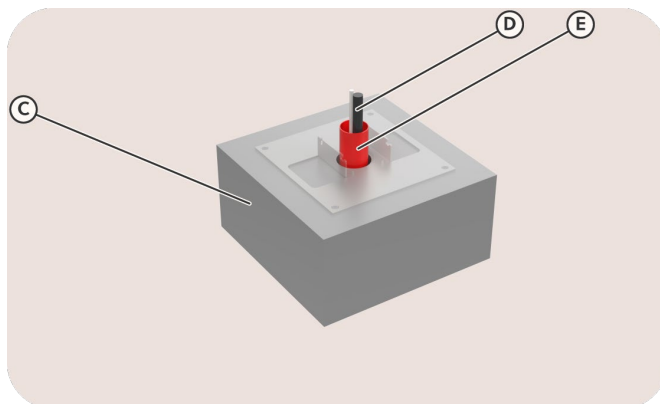

Image 7: Example of a solid foundation (C), with cables (D) in a flexible conduit system (E)

3. Fill foundation hole with concrete.

Wait for the concrete to cure before going to the next steps.

## 4.5 Prepare the EV One

### Context

For safe and compact transport of the EV One:

- The outer housing is attached to the inner structure of the EV One.
- The anchor components and a pocket with nuts are attached inside the structure.
- There are components in the Accessory Box.

For more information, refer to What's in the box (page 8).

### Instructions

Proceed as follows.

1. Remove the cardboard packaging.  
Keep in mind to store the cardboard, as this can be used to safely store the outer housing while installing the EV One.
2. Unscrew the two bottom screws at the front that hold the outer housing.  
Make sure to keep the screws for later closure of the EV One.

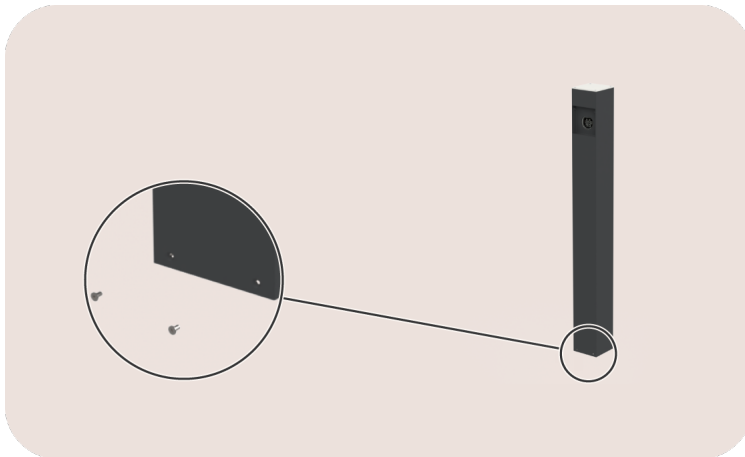

*Image 8: Front view on the EV One*

3. Slide the outer housing upwards, of the internal structure.



#### NOTE

If you use the floorplate, refer to Attach the EV One to the floorplate (page 25).

If you use the anchor, the internal structure of the EV One can be divided into two parts in function of a smooth installation. We recommend that you do not skip the next steps 4 and 5.

4. Unscrew the four nuts that hold the top part of the EV One. Make sure to keep all fasteners.

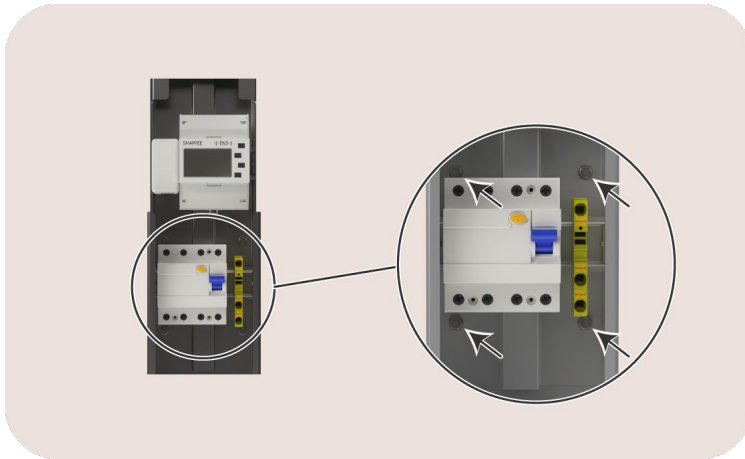

*Image 9: Rear view on the EV One*

5. Remove the top part of the EV One and set it aside in a safe location. No wires need to be disconnected, nor components removed.

As a result, the EV One is prepared for the next steps.

## 4.6 Assemble the anchor of the EV One

### Context



#### NOTE

This section is only relevant if you install the EV One at ground level with the supplied anchor. If you use the floorplate, go to Attach the EV One to the floorplate (page 25).

### Instructions

Proceed as follows.

6. Remove the anchor components from the inner structure.  
Unscrew the two nuts that hold the three anchor components to the inner structure.  
For more information, refer to Prepare the EV One (page 17).

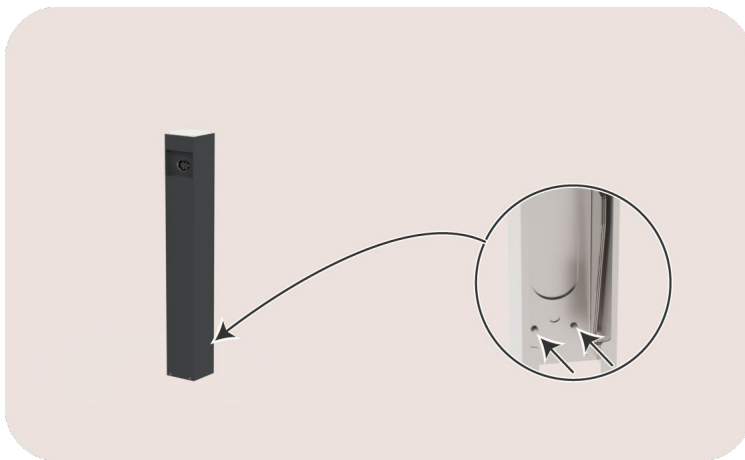

Image 10: Rear view on the bottom part of the EV One

7. Attach the component (1) to the inner structure (3).
  - Use the supplied lock nuts.
  - Make sure it is attached to the open side of the inner structure.
  - Make sure its lip is at the outer side.

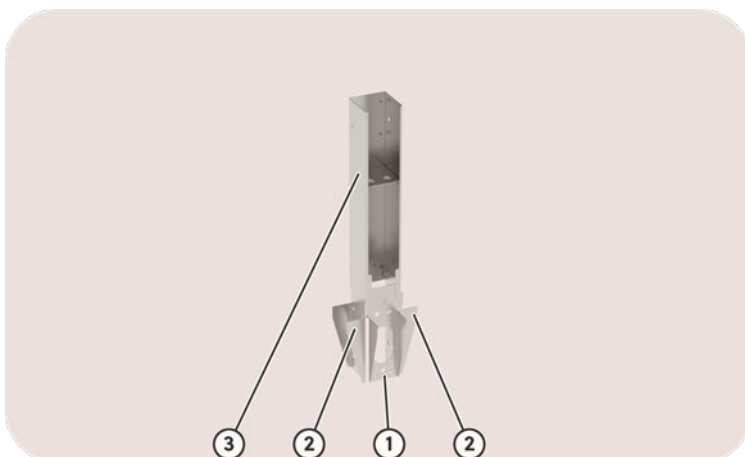

Image 11: Rear view on the anchor assembly

8. Attach the two components (2) to the left and right of the inner structure (3).  
There is no specified left or right component.

As a result, the anchor is ready for installation.

## 4.7 Install the anchor of the EV One

### Context

A stable and level ground needs to be prepared in advance. We advise a levelled concrete foundation at ground level minus the height of the anchor (40 cm).

The open side of the inner structure gives the rear of the EV One.

The top of the lip gives the bottom of the EV One.

Refer to:

- Installation prerequisites (page 14)
- Prepare the EV One (page 17)

### Instructions

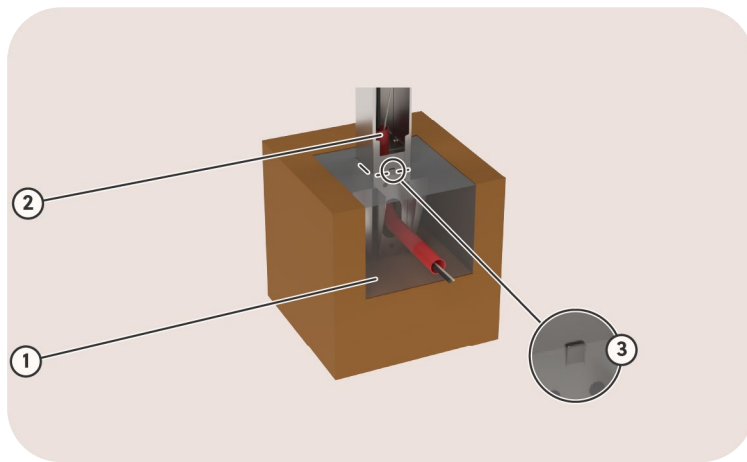

Image 12: Rear view on the anchor installation

Proceed as follows.

1. Make a foundation hole large enough to accommodate the anchor.  
Depending on the subsoil, the size may vary. Please refer to the technical specifications of size and weight to determine the dimensions for a solid foundation for the EV One.
2. Route the power supply and communication cable in a flexible conduit system through the inner structure of the EV One.
3. Fill the foundation hole with concrete.
  - It is normal that some concrete gets into the holes, which makes the anchor better attached to the foundation.
  - Make sure the top of the lip is above the concrete.
  - Make sure the inner structure is level in all directions.



#### NOTE

- Use two magnetic spirit levels to easily adjust the angle of the anchor.
- Use concrete with very fast hardening to keep the angle of the anchor.

Wait for the concrete to cure before going to the next steps.

## 4.8 Install the Smappee Infinity components

### Context

The EV One Home comes with Smappee Infinity components for measurement of:

- The total grid consumption
- The consumption of the EV charger
- The production of a single-phase solar inverter, if applicable



#### NOTE

If there is a three-phase solar inverter or if multiple inverters are present, you can purchase a Solar Add-on that has a CT Hub and two CT 50A.

These components enable overload protection and solar optimisation for your charging station. There is almost no limit to the number of measurements to control your Smappee Infinity. For more information, refer to [smappee.com](https://smappee.com) and [Smappee Academy](#).

Most Infinity components are to be installed in the distribution panel, refer to the relevant connection diagram:

- Connection diagram – 1 x 230 V (page 35)
- Connection diagram – 3 x 230 V without transformer (page 36)
- Connection diagram – 3 x 230 V with transformer (page 37)
- Connection diagram – 3 x 400 V + N (page 38)

### Instructions

Proceed as follows.

1. Locate a free circuit breaker or install an additional circuit breaker for the overload protection of the Infinity.  
Refer to Technical specifications (page 12) and local regulations.



#### NOTE

Only for situations where you need a transformer that converts the 3 x 230 V topology to a standard 3 x 400 V + N topology, you need to install an additional circuit breaker and an additional Power Box (article number i1-VAC-1).

For more information, refer to Connection diagram – 3 x 230 V with transformer (page 37) and the [Smappee Academy](#).

2. Connect the power supply cable that goes to the charging station.  
Put the Solid Core 3-Phase CT on top of the circuit breaker.

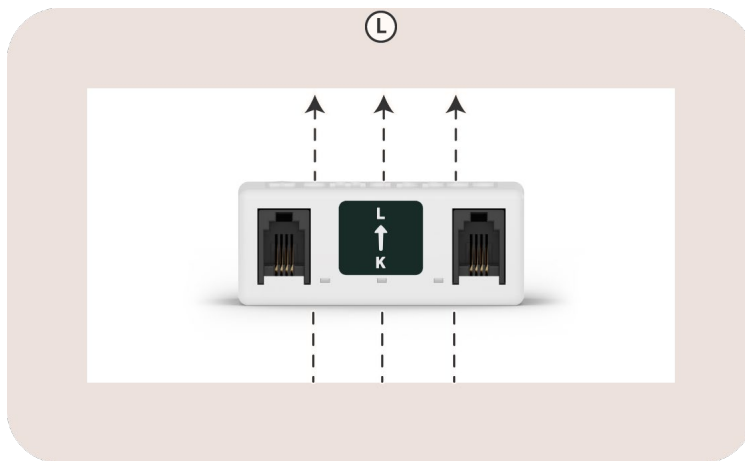

Image 13: View on the arrow on a Solid Core CT

3. Attach the current transformers:
  - That measure the power supply from the grid to the installation (L)
  - That measure the solar power to the installation (L), if applicable

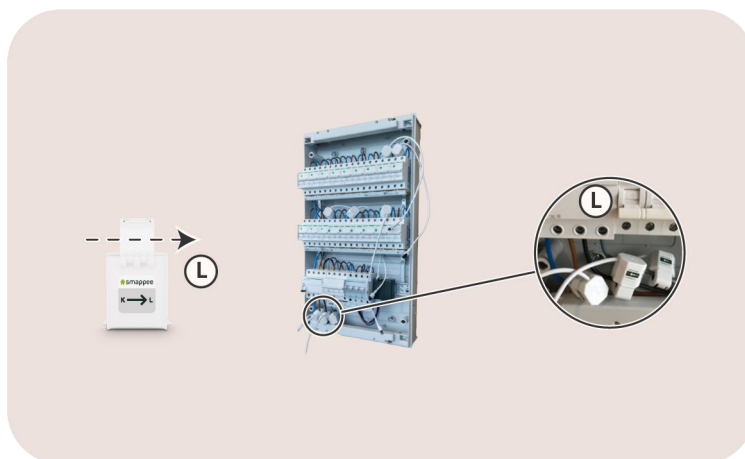





Image 14: View on the arrow on a current transformer and its installation in the distribution panel

4. Connect all current transformers to the CT Hub.  
Use a logical order, refer to the applicable connection diagram.
5. Install the DIN mounting plate for the Smappee Splitter.
6. Install the wall mounting plate for the Smappee Connect next to the distribution panel.  
The LED of the Smappee Connect indicates the status of the system. For more information, refer to Status of the Smappee Connect (page 39).
7. Connect the Smappee Infinity with the cables as indicated on the connection diagram.
  - The Smappee Connect is connected to the B-port of the Smappee Splitter.
  - The Solid Core 3-Phase CT is connected to the A-port of the CT Hub.
  - The CT Hub is connected to the A-port of the Smappee Splitter.
  - The bus termination plug is connected to the free A-port.
  - The network cable for wired internet goes to the RJ45 port of the Smappee Connect.

# 5 Installation and activation

This procedure describes the required steps for the physical installation of the EV One Home.

	<p><b>CAUTION</b></p> <p>The installation must be carried out by a qualified professional who has read this manual and works in compliance with local and national standards. Neglecting this may lead to severe injuries or hazardous situations while working with electricity.</p>
	<p><b>CAUTION</b></p> <p>The electric system must be entirely disconnected from every power source prior to performing installation or maintenance work. Make sure it is not possible to connect the electric current during installation. Put up caution tape and warning signs to mark the work areas. Make sure no unauthorised people can enter the work areas.</p>
	<p><b>CAUTION</b></p> <p>The charging station contains electric components that may still contain electrical charge after being disconnected. Wait at least 10 seconds after disconnection before commencing work.</p>
	<p><b>CAUTION</b></p> <p>Adaptors or conversion adaptors and cord extension sets are not allowed to be used.</p>

This procedure describes the required steps for the physical installation of the EV One.

1. Attach the EV One (page 24)
2. Connect the power supply of the EV One (page 27)
3. Connect the EV One Home to Smappee Infinity (page 29)

After the physical installation, the configuration can be done. For more information, refer to:

4. Configure the EV One with the Smappee App (page 31)
5. Complete the installation of the EV One (page 33)

## 5.1 Attach the EV One

The supplied anchor or a floorplate must be used to attach the EV One. For more information, refer to:

- Attach the EV One to the anchor (page 24)
- Attach the EV One to the floorplate (page 25)

### Attach the EV One to the anchor

#### Context



#### NOTE

This section is only relevant if you install the EV One at ground level with the supplied anchor. If you use the floorplate, refer to Attach the EV One to the floorplate (page 25).

You have divided the EV One into two parts and used the bottom part during installation of the anchor. For more information, refer to:

- Prepare the EV One (page 17)
- Assemble the anchor of the EV One (page 19)
- Install the anchor of the EV One (page 20)

#### Instructions

Attach the top part to the bottom part. Make sure to use the fasteners.

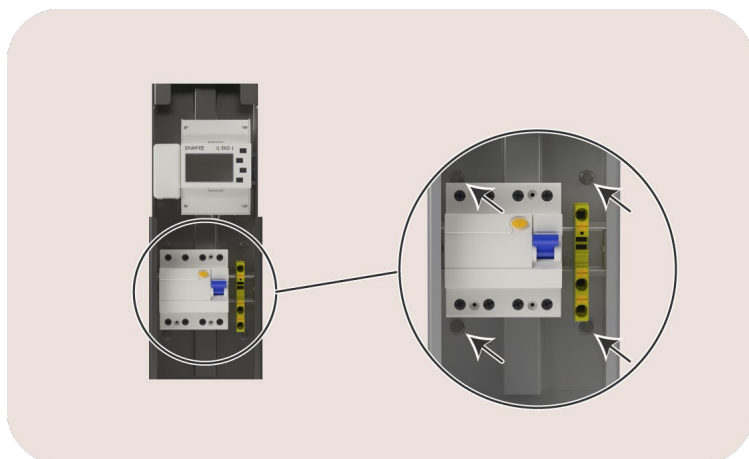

Image 15: Rear view on the EV One

## Attach the EV One to the floorplate

### Prerequisites



#### NOTE

This section is only relevant if you install the EV One at ground level with the optional floorplate. If you use the anchor, refer to Prepare the EV One (page 17).

We recommend a levelled concrete foundation at ground level. This can be a polished concrete floor in a parking garage or a paved area for installation of the charging stations.

Route the power supply cable and the communication cable through the central opening of the floorplate.

### Context

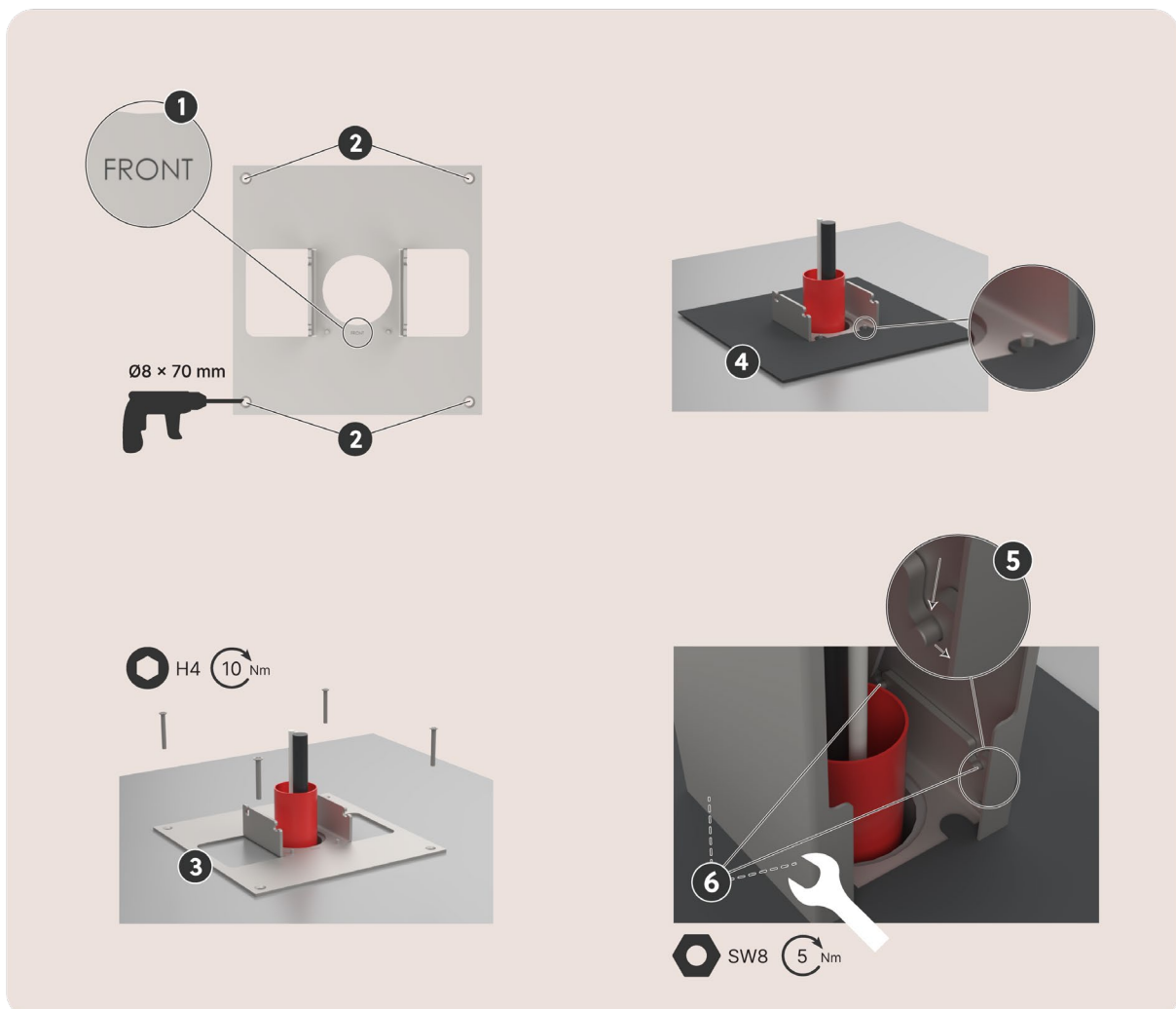

Image 16: View on the quick install guide

## Instructions

Proceed as follows.

1. Put the floorplate in the correct position.  
Pay attention to turn it with the FRONT indication to the side where the socket will come.
2. Drill the four holes of  $\varnothing 8 \times 70$  mm.  
Make sure the hole is free of small particles.
3. Attach the floorplate to the foundation.  
Insert the anchor screw until the head is at the same level as the floorplate.  
Use a hammer if necessary.  
Tighten the screws to 10 Nm with a hex key 4.
4. Put the cover plate over the floorplate.  
There is only one direction the studs fit into the holes at the front.
5. Put the structure of the EV One over the floorplate.  
Move vertically in the slot and then move horizontally.
6. Tighten the four nuts.  
The nuts are supplied with the EV One, refer to What's in the box (page 8).  
Tighten the nuts to 5 Nm with an 8 mm socket.

As a result, the structure is locked to the floorplate.

## 5.2 Connect the power supply of the EV One

### Context

The EV One must have its own circuit breaker. For more information, refer to Installation prerequisites (page 14).

### Instructions

1. Guide the power supply cable through the cable gland. Tighten the cable gland.



Image 17: View on the holes for the cable entry

2. Cut the power supply cable to the sufficient length. For stranded wires, add a wire end ferrule to each conductor.
3. Connect the power supply wires as follows:

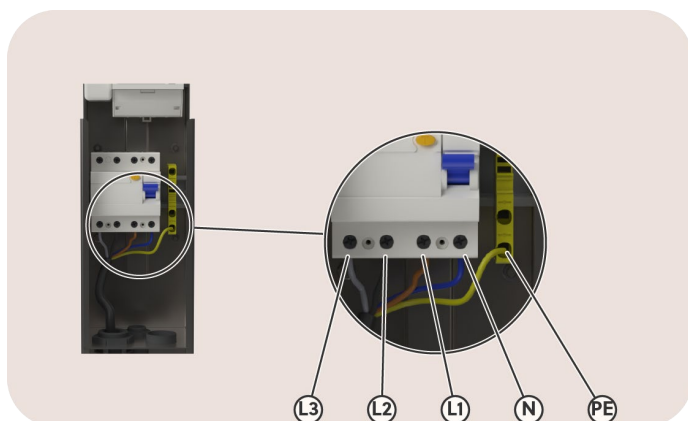

Image 18: View on the power supply connection

- Put the green/yellow conductor in the corresponding terminal block for the protective earth (PE).
- Put the blue conductor, if applicable, in the corresponding connection point for the neutral (N) of the residual current device.



#### NOTE

For a 3 x 230 V with a transformer, the neutral wire comes from the transformer. The two RJ10 cables of the Power Box in the charging station must be disconnected.

- Put the phase conductors in the necessary connection point of the residual current device.

	<p><b>NOTE</b></p> <ul style="list-style-type: none"><li>• L1 = brown phase 1-conductor</li><li>• L2 = black phase 2-conductor, if applicable</li><li>• L3 = grey phase 3-conductor, if applicable</li></ul> <p>For a 3 x 230 V without a transformer, and thus no neutral conductor, put the grey conductor in the neutral connection point.</p>
---	---

4. Make sure that the residual current device is set to the on position.  
The on position is shown in Image 18.

As a result, the EV One is almost ready for power.

## 5.3 Connect the EV One Home to Smappee Infinity

### Context



#### CAUTION

Risk of electric shock.

Make sure no tools are in the charging station and people stand free from the charging station.

### Instructions

Proceed as follows.

1. Guide the communication cable through the cable gland.

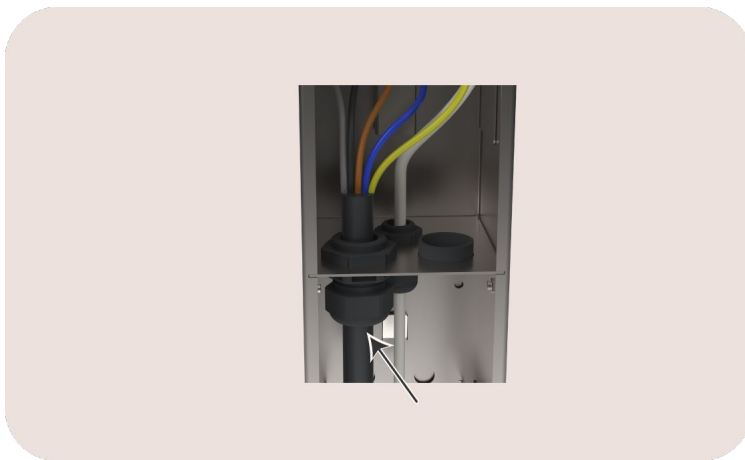

Image 19: View on the holes for the cable entry

2. Cut the communication cable to the necessary length.
3. Attach the RJ45 connector (not supplied).
4. Put the connector in the A+B port of the relay board.

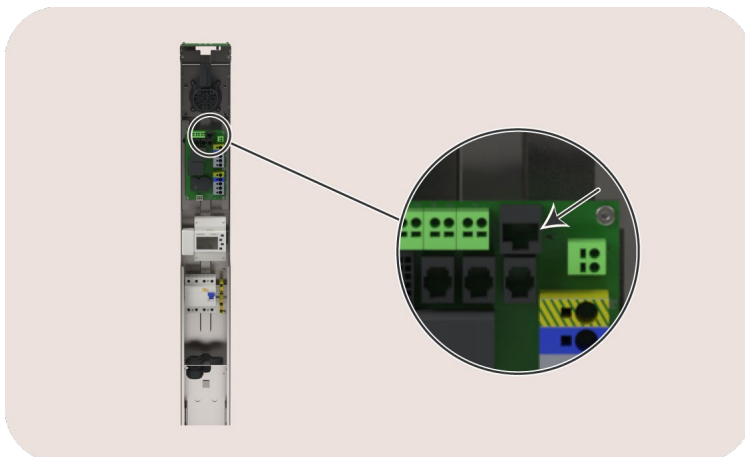

Image 20: View on the A+B port

The communication cable between the charging station and the Smappee Splitter makes the data from the charging station and the Smappee Infinity components can go via the Smappee Connect to the Smappee Cloud.

5. Tighten the cable gland.

6. Start the power supply to the EV One and the Power Box.
7. Check the status of the components after approximately 30 seconds.

Description	More information
1 x Smappee Connect	LED is lighting up
1 x Power Box	LED is flashing once every 3 seconds.
1 x CT Hub	
1 x Solid Core 3-Phase CT	

For more information, refer to the annex Colour code explanation (page 39).

8. Stop the power supply to the EV One.

## 5.4 Configure the EV One with the Smappee App

### Prerequisites

This procedure is done with the Smappee App. You can download this mobile app from the Apple App Store for iOS or the Google Play store for Android phones.



Image 21: Download the Smappee App

### Instructions

Proceed as follows:

1. Open the Smappee App.  
Login to the Smappee App with your partner user account.

**NOTE**

If you have not yet a partner user account, go to <https://forms.office.com/e/zxWJq7QqUc>.

2. Tap the **House** button.
3. Tap the **+** button.
4. Tap the **I want to install a Smappee charging station** Button.
5. Follow the steps shown in the Smappee App.

**NOTE**

If you have the power supply 3 x 230 V, you need configure the CT's as follows:

Single phase load powered by	Connect the clamp around	Configure in Smappee App
L1 and L3	L1	L1
L2 and L3	L2	L2
L1 and L2	L1	L3



#### NOTE

If the EV will not charge on a 3 x 230 V without transformer, you can try to disconnect the L2 cable going to the socket.

Do not disconnect the L2 of the power supply cable.

#### Post-requisites

The settings of your charging station can be adjusted in the Smappee App or the Smappee Dashboard.

- Name
- LED brightness
- Maximum current per connector and thus the charging speed per connector

## 5.5 Complete the installation of the EV One

### Instructions

Proceed as follows.

1. Slide the housing over the inner structure.  
Make sure the opening is in line with the socket on the inner structure.
2. Tighten the screws at the bottom of the housing.  
These screws are removed at the beginning of the installation.

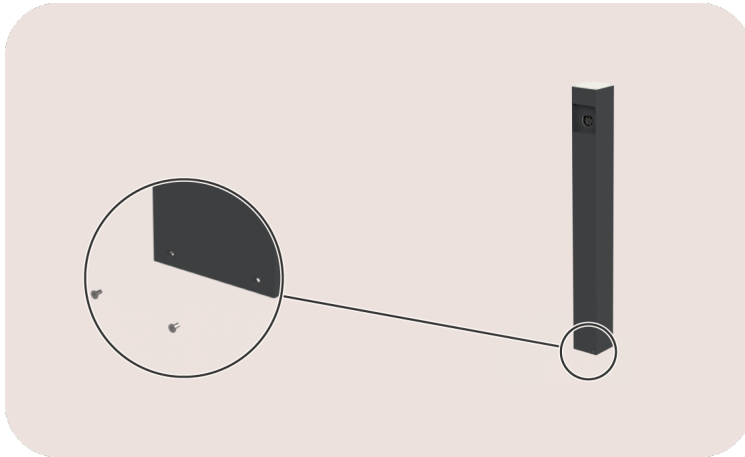

*Image 22: Front view on the EV One*

3. Attach the door to protect the socket with the provided screws.  
Place the door in a horizontal position for easiest access to mount the screws.  
Verify the door can move without friction.

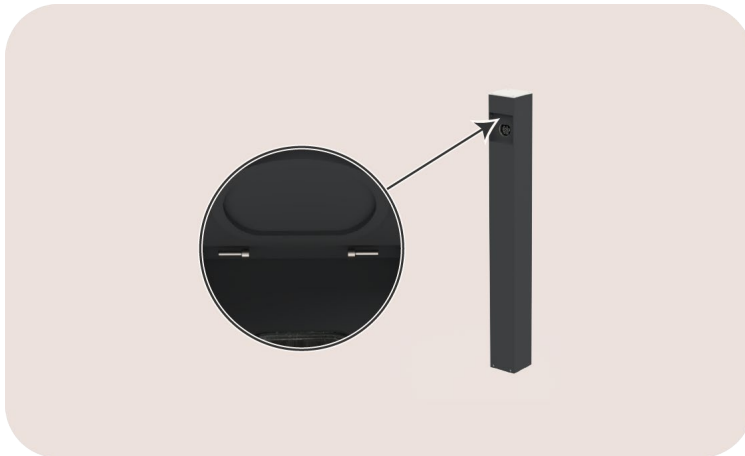

*Image 23: View on the door screws*

# Annexes

## Declaration of conformity

# EU Declaration of conformity



**Manufacturer**            **Smappee NV**  
Address                    Evolis 104, 8530 Harelbeke, Belgium

**Represented by**        **Kurt Vandeputte**  
Function                   CEO

**Hereby declares, under the sole responsibility of the manufacturer, that**

The product                **AC conductive charging equipment**

Models                     EVO-332-B-E-B

**Complies with the requirements of the following EU Directives, provided that it is installed, maintained, and used according to the manufacturer's instructions**

- 2014/35/EU The Low Voltage Directive
- 2014/30/EU The Electromagnetic Compatibility Directive
- 2014/53/EU The Radio Equipment Directive
- 2011/65/EU RoHS Directive

### Standards applied

Safety                      EN IEC 61851-1 2019/AC:2024 Electric vehicle conductive charging system - General requirements  
EN IEC 62311:2020 Assessment of electronic and electrical equipment related to human exposure restrictions for electromagnetic fields

EMC                         EN IEC 61851-21-2:2018 EMC requirements for off board electric vehicle charging systems  
ETSI EN 301 489-1 V2.2.3: EMC for radio equipment and services;  
Part 1: Common technical requirements  
ETSI EN 301 489-3 V2.2.3: EMC for radio equipment and services;  
Part 3: Specific conditions for Short Range Devices (SRD)

Radio                        ETSI EN 300 330 V2.1.1 Short Range Devices (SRD);  
Radio and inductive loop systems

Authorised signatory

**Kurt Vandeputte**  
CEO





## Connection diagram – 3 x 230 V without transformer

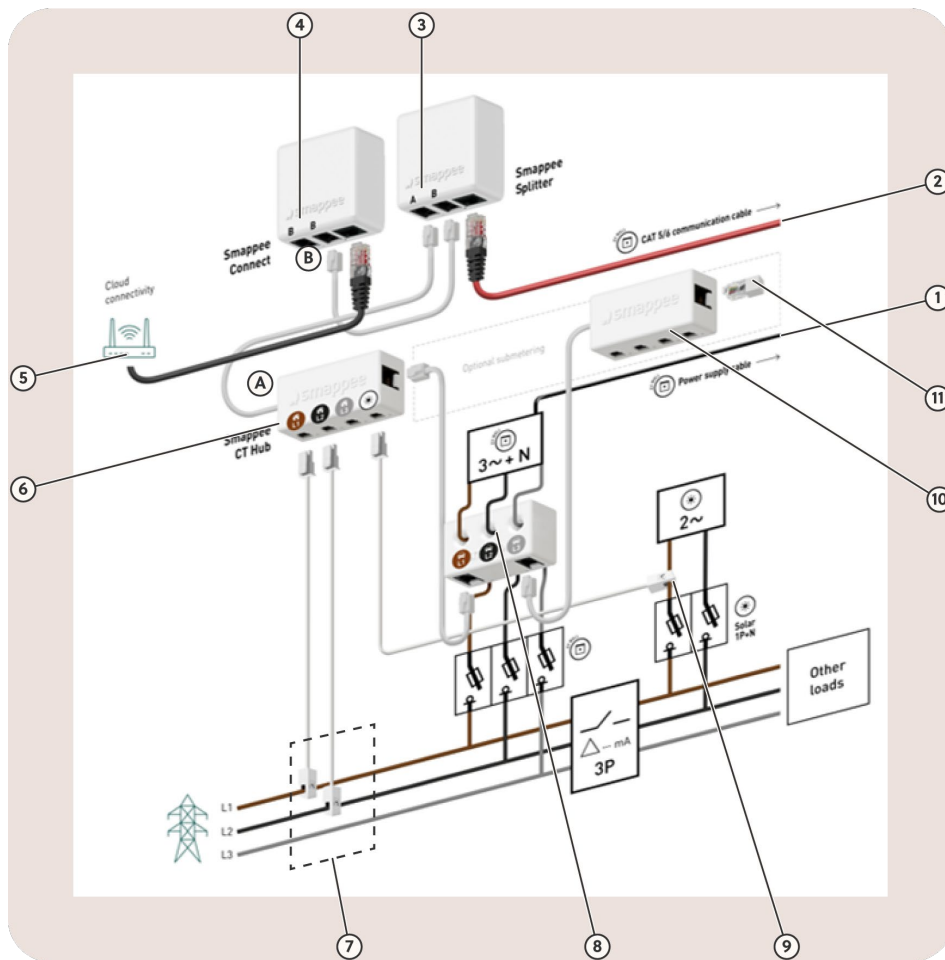

Image 25: Connection diagram 3 x 230 V – without transformer

ID	Description	More information
1	Power supply cable	With dedicated circuit breaker for the charging station
2	Communication cable	Communication between the Smappee Infinity and the charging station
3	Smappee Splitter	Makes data from the A+B port of the charging station goes to the A-bus or the B-bus
4	Smappee Connect	Gateway for communication with the Smappee Cloud
5	Network cable	For wired connection of the gateway to the internet Power over Ethernet is not supported by the gateways.
6	CT Hub	Transfers data from current transformers
7	3 x CT	Current transformers that measure each phase of the power supply from the grid
8	Solid Core 3-Phase CT	Current transformer with a solid body to put three wires to the charging station through
9	1 x CT	Current transformer that measures a single-phase solar production
10	CT Hub	Additional Smappee Infinity components can be installed for more submetering.
11	Bus termination plug	Closes the A-bus.

### Connection diagram – 3 x 230 V with transformer

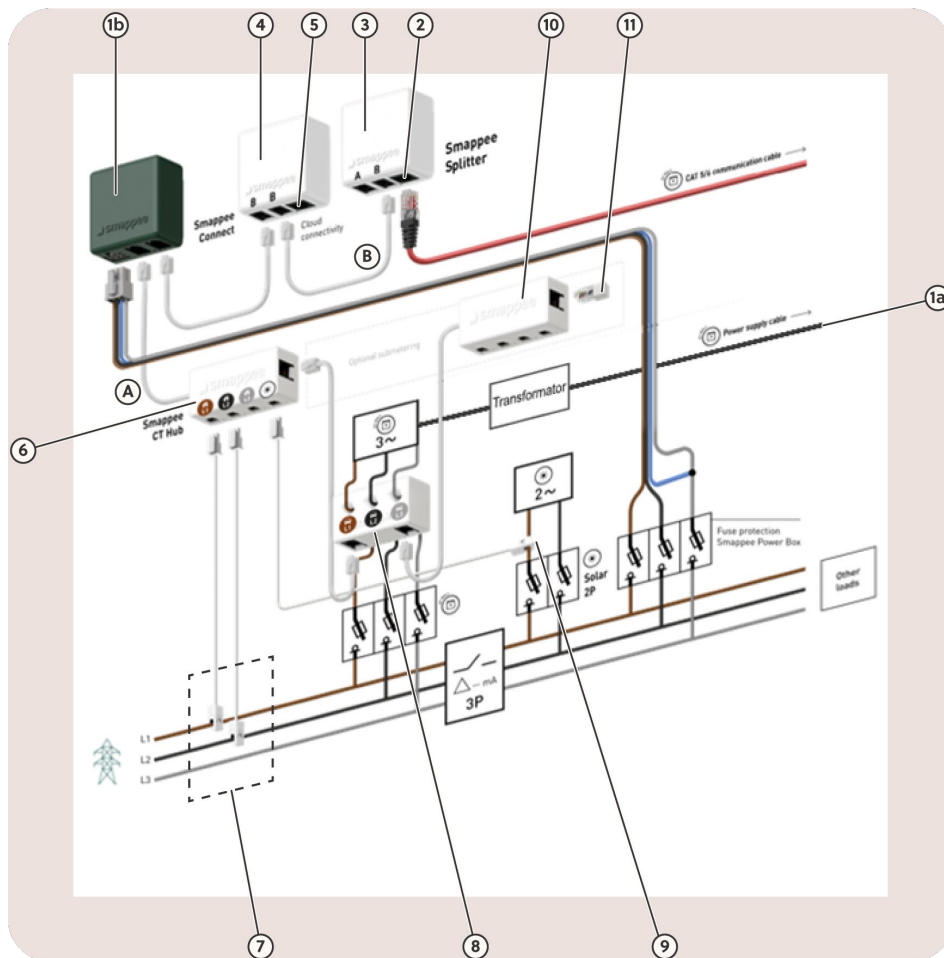

Image 26: Connection diagram 3 x 230 V – with transformer

ID	Description	More information
1a	Power supply cable	With dedicated circuit breaker for the charging station
1b	Power Box	With dedicated circuit breaker for the Infinity
2	Communication cable	Communication between the Smappee Infinity and the charging station
3	Smappee Splitter	Makes data from the A+B port of the charging station goes to the A-bus or the B-bus
4	Smappee Connect	Gateway for communication with the Smappee Cloud
5	Network cable	For wired connection of the gateway to the internet Power over Ethernet is not supported by the gateways.
6	CT Hub	Transfers data from current transformers
7	3 x CT	Current transformers that measure each phase of the power supply from the grid
8	Solid Core 3-Phase CT	Current transformer with a solid body to put three wires to the charging station through
9	1 x CT	Current transformer that measures a single-phase solar production
10	CT Hub	Additional Smappee Infinity components can be installed for more submetering.
11	Bus termination plug	Closes the A-bus.

## Connection diagram – 3 x 400 V + N

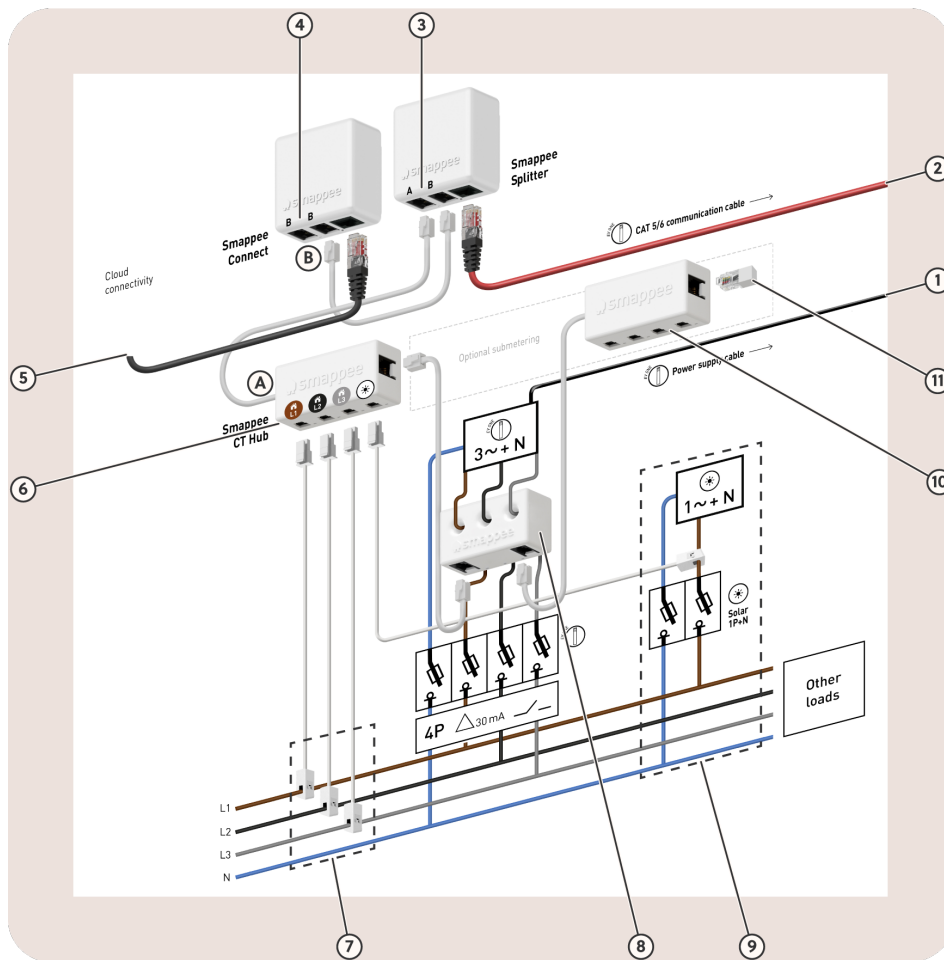

Image 27: Connection diagram 3 x 400 V + N

ID	Description	More information
1	Power supply cable	With dedicated circuit breaker for the charging station
2	Communication cable	Communication between the Smappee Infinity and the charging station
3	Smappee Splitter	Makes data from the A+B port of the charging station goes to the A-bus or the B-bus
4	Smappee Connect	Gateway for communication with the Smappee Cloud
5	Network cable	For wired connection of the gateway to the internet Power over Ethernet is not supported by the gateways.
6	CT Hub	Transfers data from current transformers
7	3 x CT	Current transformers that measure each phase of the power supply from the grid
8	Solid Core 3-Phase CT	Current transformer with a solid body to put three wires to the charging station through
9	1 x CT	Current transformer that measures a single-phase solar production
10	CT Hub	Additional Smappee Infinity components can be installed for more submetering.
11	Bus termination plug	Closes the A-bus.

## Colour code explanation

### Status of the Smappee Connect

This status is relevant during the configuration and use of the charging station.

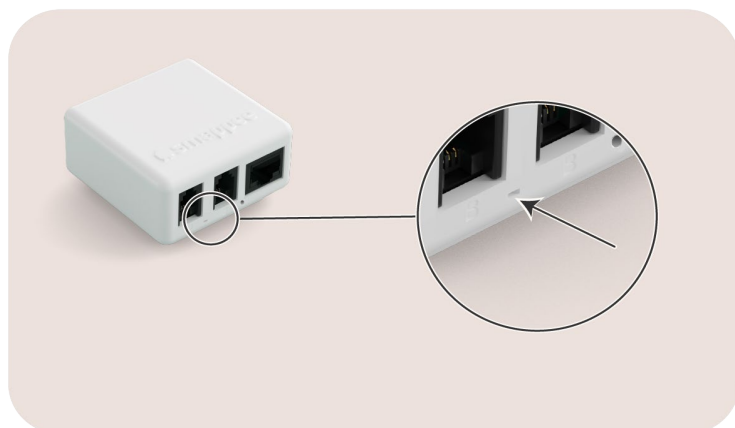







Image 28: Position of the LED on the Smappee Connect

Colour	Status	Meaning	More information
	Blue continuous	Starting up	The Connect is starting up. If this takes more than 30 seconds, please contact support.
	Blue flashing	Ready for connecting	The Connect is ready to be connected to the network.
	Green continuous	Connecting	The Connect is connecting to the internet and must become <i>Green breathing</i> . If this takes more than 2 minutes, please contact support.
	Green breathing	All good	The Connect operates correctly.
	Red flashing	No connection	The Connect has no connection to the internet during start-up. Find the cause of the connection issue or contact support.

### Smappee Power Box

<b>LED status</b>	<b>Meaning</b>
Status LED is flashing once every 3 seconds.	The Power Box is powered on and operating correctly.
Status LED is flashing once every 1 second.	Smappee Bus B error.

### Smappee CT Hub

<b>LED status</b>	<b>Meaning</b>
LED at input A, B, C or D 3 pulses per second, on any of the inputs A, B, C, D.	Indication of the selected CT input during the CT configuration.
LED at input A Short pulse every 3 seconds.	The CT Hub is powered on and operating correctly.
LED at input A One pulse every second.	Communication error.
LED at input A 2 pulses per second.	Configuration problem.

### Smappee Solid Core 3-Phase CT







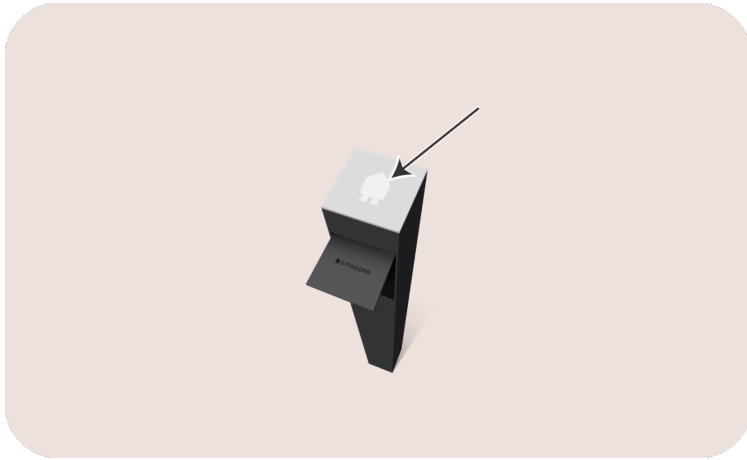

<b>LED status</b>	<b>Meaning</b>
LED at input A, B, C or D 3 pulses per second, on any of the inputs A, B, C, D.	Indication of the selected input during configuration.
LED at input A Short pulse every 3 seconds.	The Solid Core 3-Phase CT is powered on and operating correctly.
LED at input A One pulse every second.	Communication error.
LED at input A 2 pulses per second.	Configuration problem.

### Status of the charging station

This status is relevant during the use of the charging station.





*Image 29: Position of the RFID reader with LED on the EV One*

<b>Colour</b>	<b>Status</b>	<b>Meaning</b>	<b>Action of the user</b>
	Red continuous	Charging station is unavailable.	Something is wrong or the charging station has been disabled. Enable the charging station with the Smappee App or contact your installer.
	White continuous	Charging station is available.	Connect your electric vehicle (EV) with the charging station.
	Blue continuous	EV is connected to the charging station but is not yet charging.	If no authorisation is necessary, wait 3 seconds until you hear a sound and the LED is green. If the LED stays blue, do one of the following: <ul style="list-style-type: none"> <li>• Swipe your RFID tag (charge card, RFID key, ...) along the blue indicator of the charging station.</li> <li>• Scan the QR code, if applicable</li> </ul>
	Blue flashing	Authorisation is being verified.	Wait 15 seconds until the authorisation is finished and you hear a sound. The LED is red if charging has not started or green if charging has started.
	Red flashing	RFID tag is not authorised.	Contact the supplier of the RFID tag.
	Green breathing	EV is being charged.	Your EV is being charged.
	Green flashing	Charging session is waiting to charge or paused by an overload	This is informative, no action required.
	Green continuous	EV is charged	Disconnect the charging cable and put it safely back in the storage place.

## Maintenance schedule

To ensure safe and reliable operation, periodic maintenance and inspections are recommended. The frequency depends on usage and environmental conditions.

	<p><b>WARNING</b></p> <p>Before starting maintenance activities, consider all safety precautions as listed in Safety instructions (page 5).</p>
---	---

	<p><b>NOTE</b></p> <p>For publicly accessible charging stations, periodic inspections may be required by local regulations. Check applicable guidelines for compliance.</p>
---	---

Task	More information
Visual inspection of the charging station	Check for visible damage or wear. If necessary, consult an installer for assessment or replacement.
Cleaning	Cleaning is optional and does not affect the operation of the charging station. For aesthetic reasons, you may wipe the unit with a dry, clean cloth. Do not use water jets, solvents, or abrasive materials.

## Spare parts list

Article no.	EAN	Description
i1-GW-3	5425036931442	Smappee Connect
i1-VAC-1	5425036931169	Smappee Power Box
AC-RCDA-4P40A	5425036935532	RCD Type A 4P 30mA 40A
EV-PCB-SIGNALBOARD-1	5425036935549	EV Line Charge controller + RFID Reader
EV-PCB-RELAYBOARD-2x2P-1	5425036935556	EV Line Relayboard 2 x 2P
EV-CABLE-12P-1	5425036935587	12P cable EV_charg 0,5m
AC-AB-SPLITTER	5425036935334	A_B Splitter
FLOOR-PLATE-TUBE120	5425036934719	Floor plate for EV One or Pay Station 120 mm x 120 mm
AC-IBC40-10	5425036935648	Smart Bus RJ10 Cable 40 cm - 10 pieces

If you need another part than listed, please contact [info@smappee.com](mailto:info@smappee.com).