

EV One

Quick install guide



Safety warning

Carrying out electrical work within the home or workplace can be dangerous and must be conducted according to the appropriate national safety standards and executed by a certified electrician. For safety purposes, it is also necessary to power off the installation before proceeding with the physical installation.

Veiligheidswaarschuwing

Elektrische werkzaamheden in huis of op het werk kunnen gevaarlijk zijn en moeten worden uitgevoerd volgens de geldende nationale veiligheidsnormen en door een erkende elektricien. Om veiligheidsredenen is het ook nodig de stroom van de installatie uit te schakelen voordat u verder gaat met de fysieke installatie.

Avertissement de sécurité

Les travaux électriques à domicile ou sur le lieu de travail peuvent être dangereux et doivent être effectués conformément aux normes de sécurité nationales appropriées et exécutés par un électricien certifié. Pour des raisons de sécurité, il est également nécessaire de mettre l'installation hors tension avant de procéder à l'installation physique.

Sicherheitshinweis

Die Ausführung von Elektroarbeiten im Haus oder am Arbeitsplatz kann gefährlich sein und muss gemäß den entsprechenden nationalen Sicherheitsnormen und von einem zertifizierten Elektriker durchgeführt werden. Aus Sicherheitsgründen ist es außerdem notwendig, die Anlage auszuschalten, bevor man mit der physischen Installation fortfährt.

Full installation manual



Volledige
installatiehandleiding



Manuel d'installation
complet



Vollständiges
Installationsanleitung



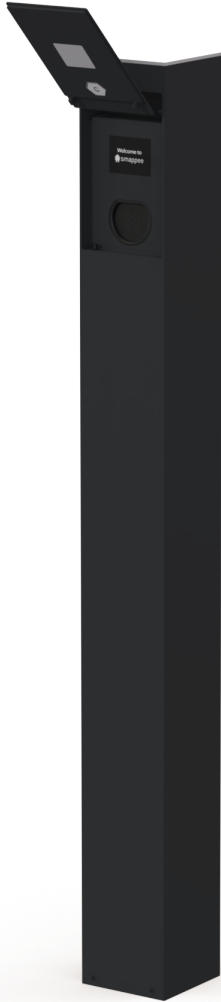

EVO-332-B-B



EV One



Door



Door screw



Anchor nut



Spare door screw

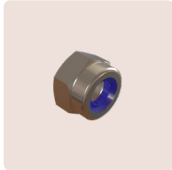

Spare anchor nut



Spare Safety screw



Safety screw bit



Plug ø20

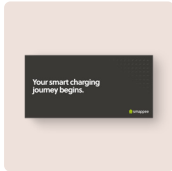

Starter box



Optional: FLOOR-PLATE-TUBE120

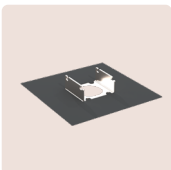

Floorplate



1

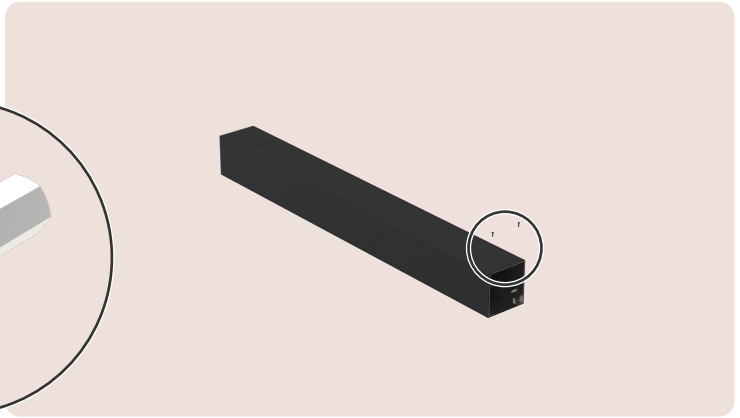
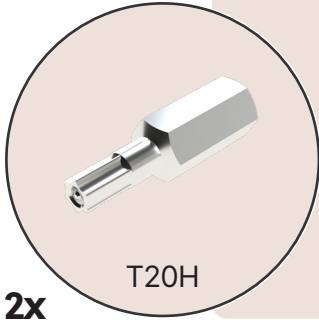

2

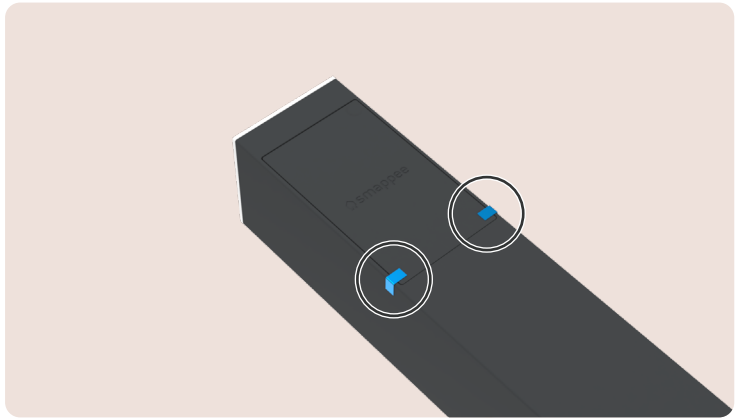

3

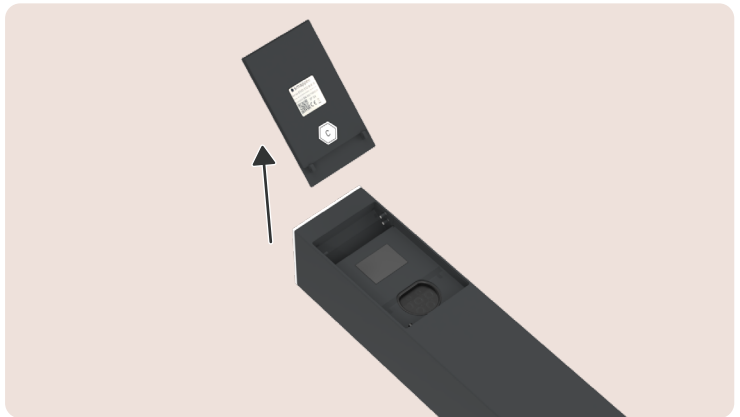

4

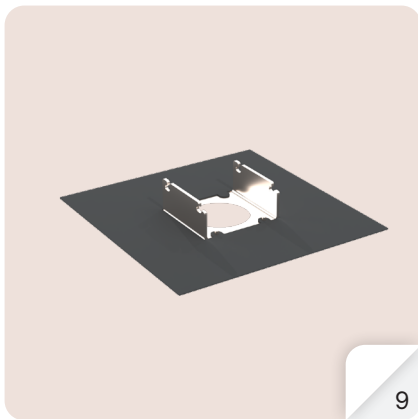
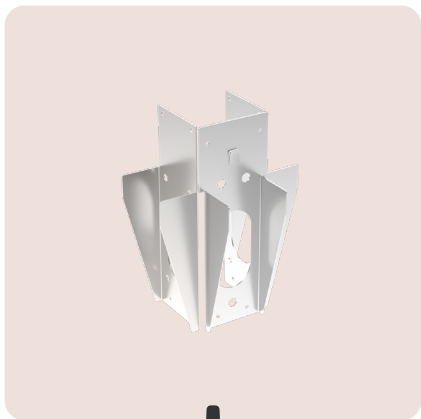
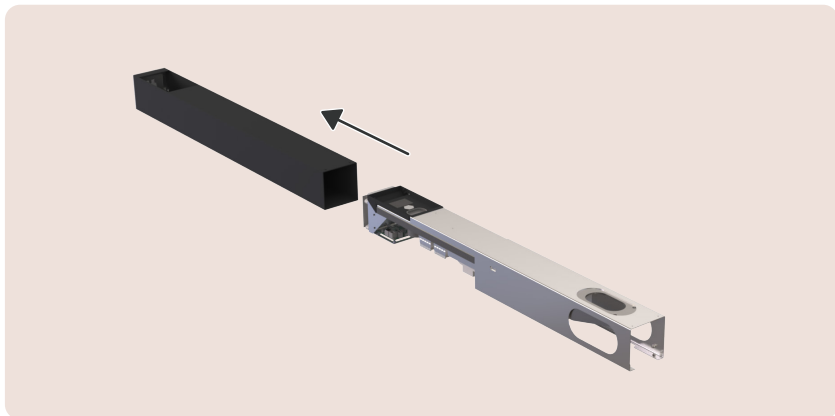

5

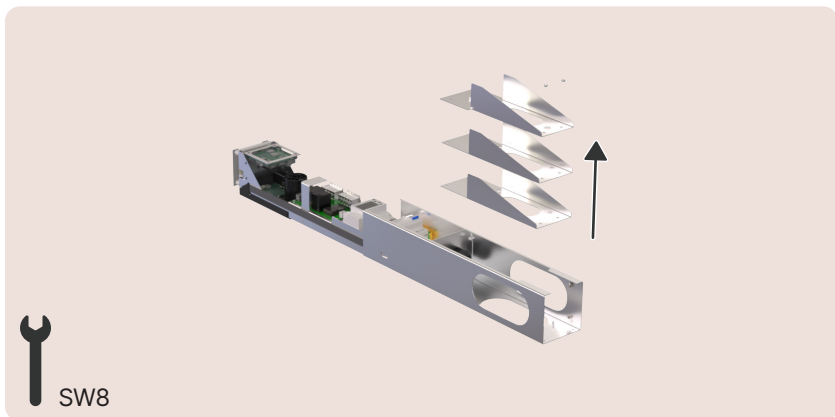

6

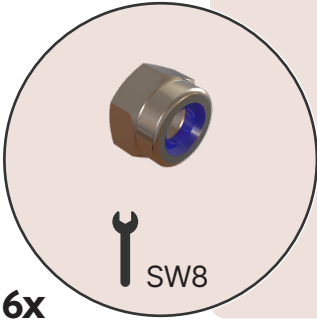
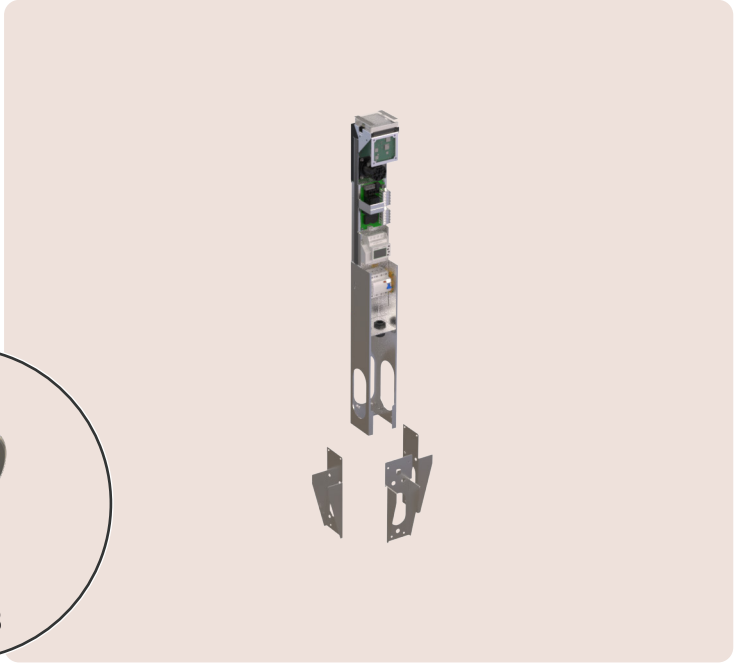

6x

7

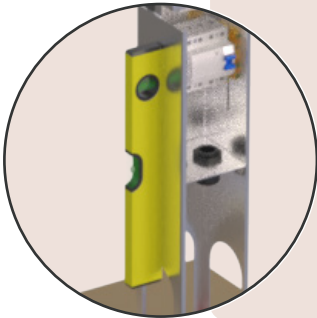
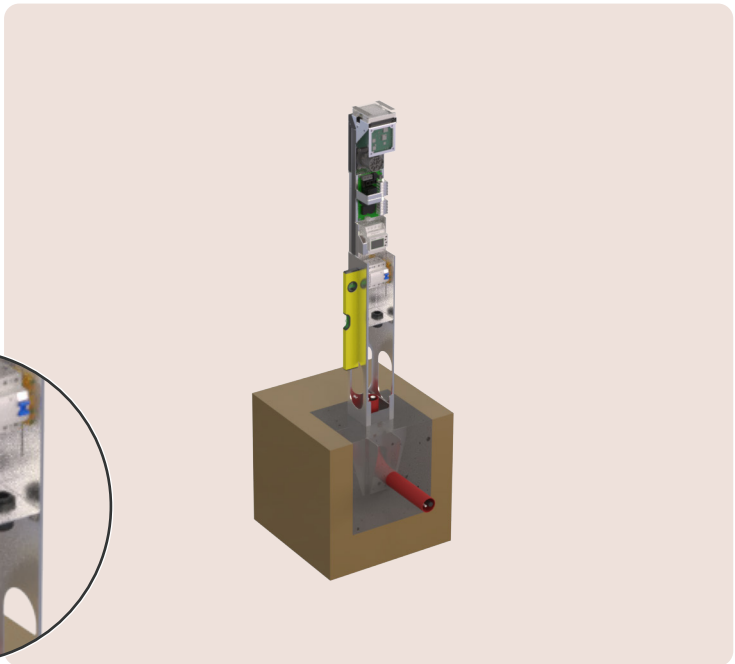

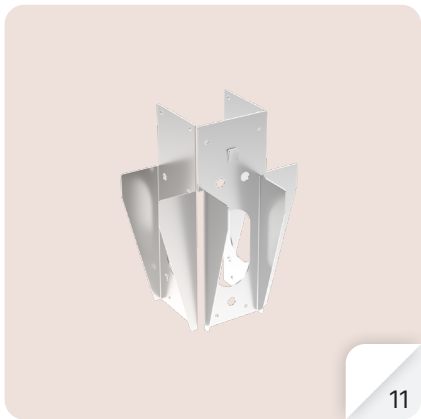
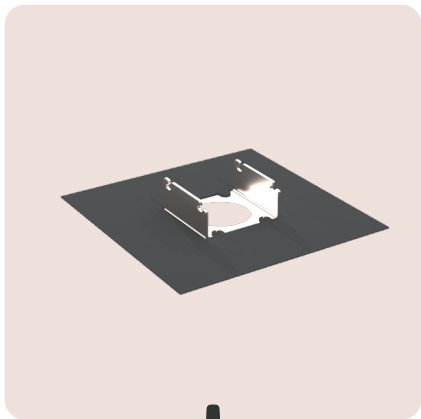

5

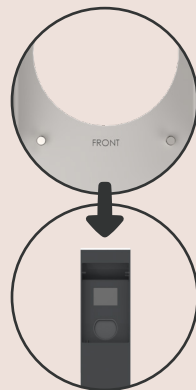
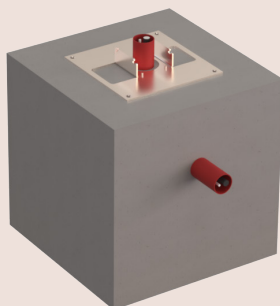
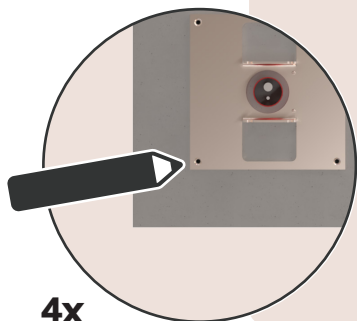

4x

6

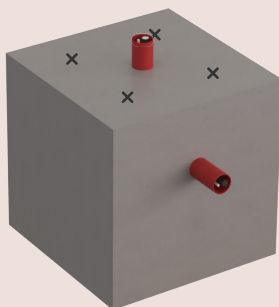
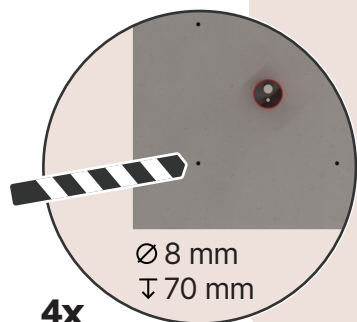

7

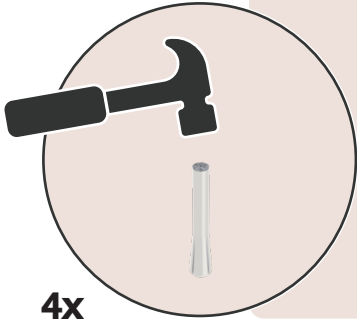

4x

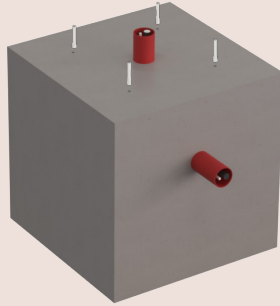

8

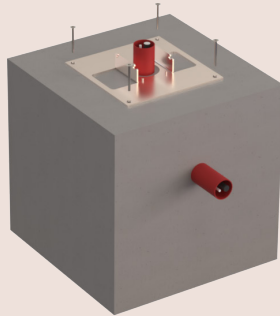

H4 | 10 Nm

9

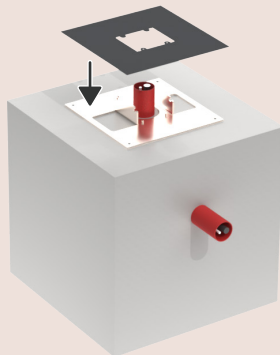

10

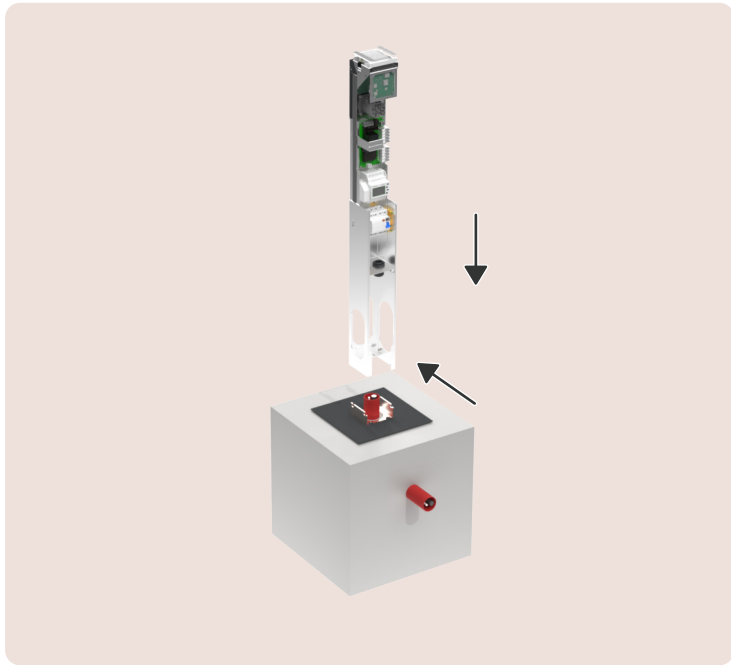

11

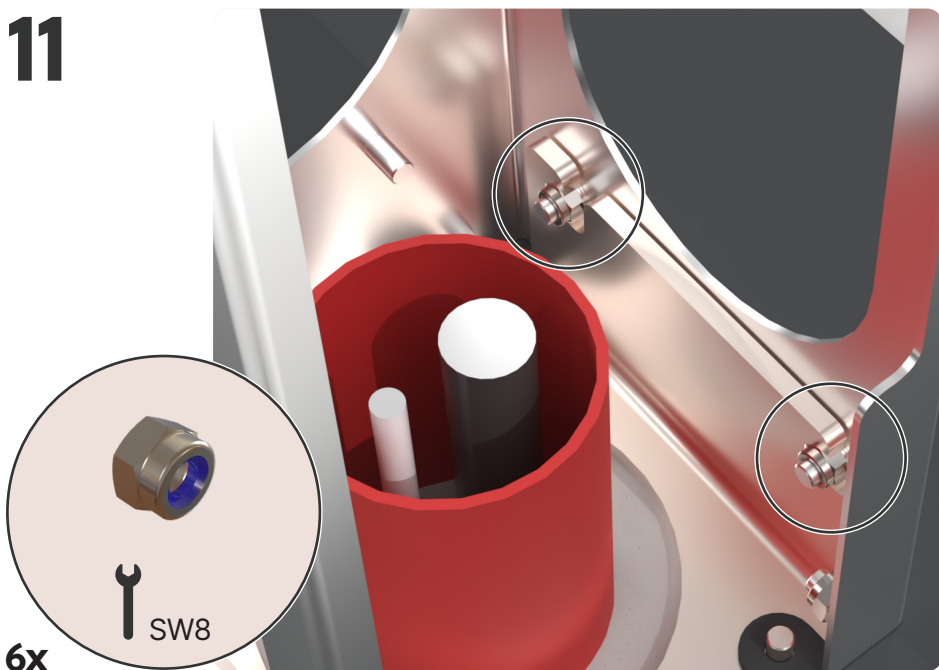

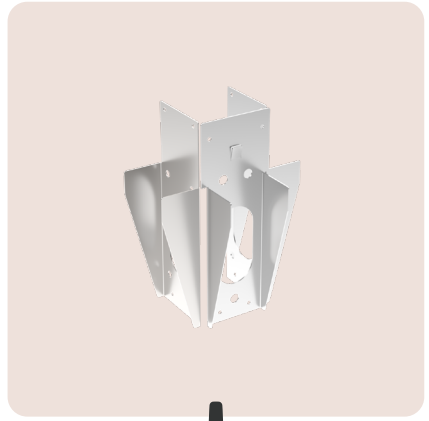
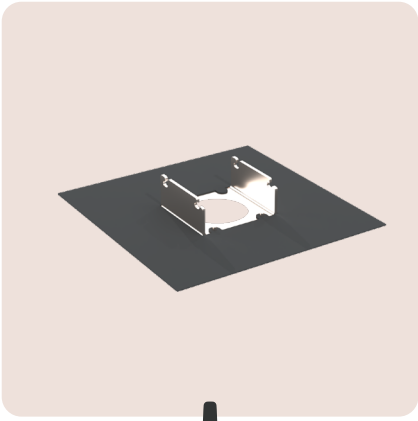

12

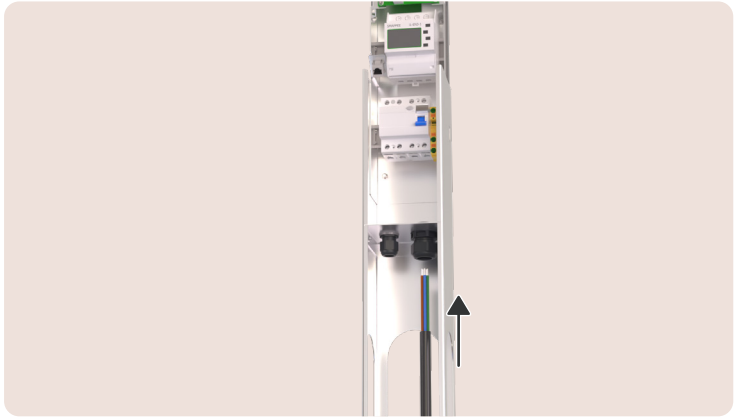

13

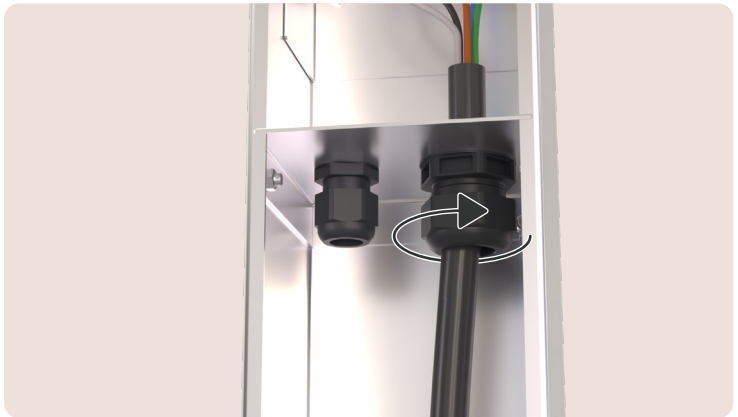

14

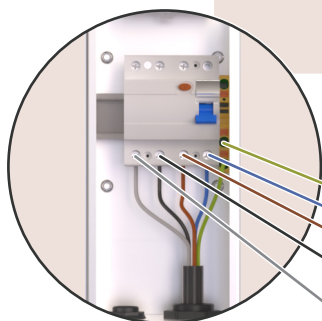

 
↓ PZ2 | 2,5 Nm



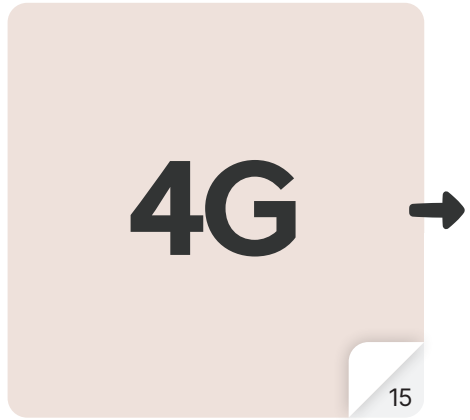
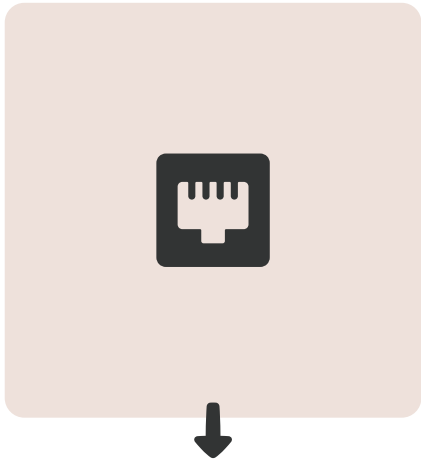

15

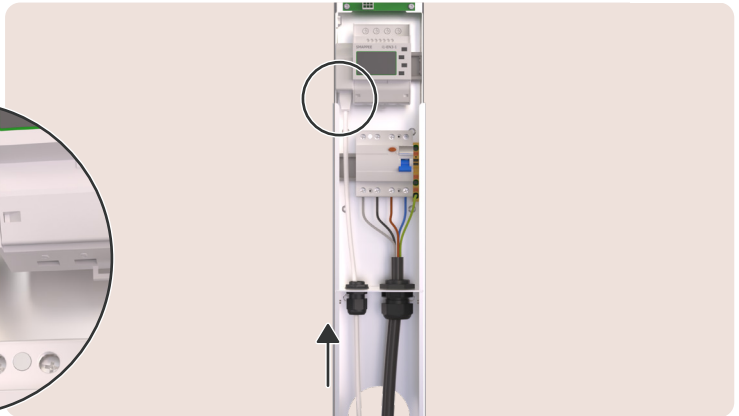
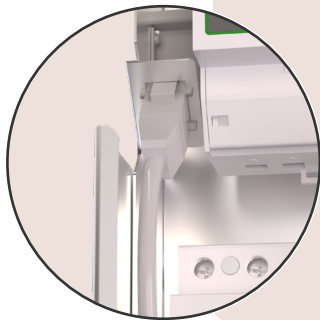

16

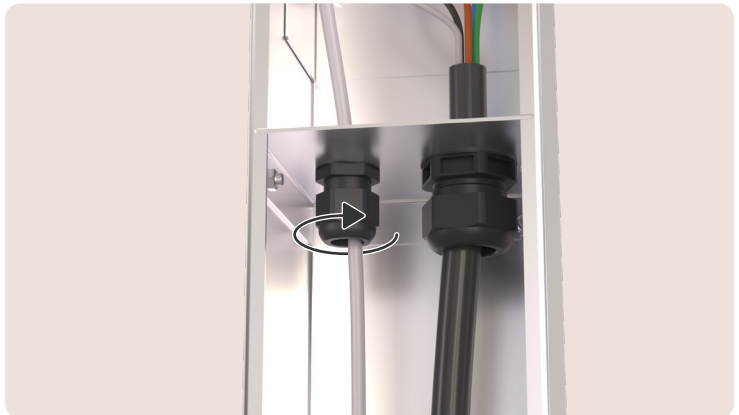

15



16

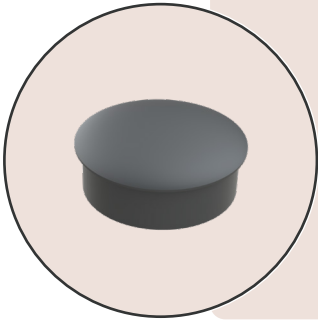

17

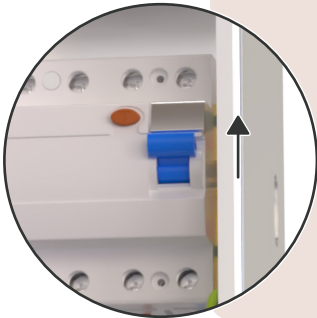

🕒 60 sec

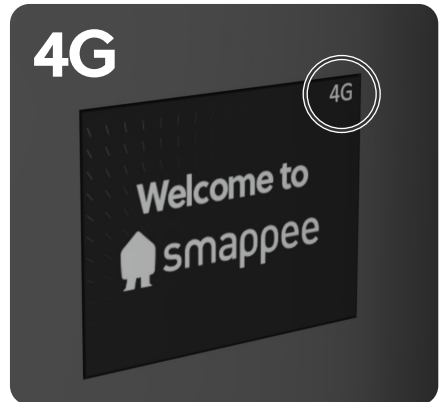

18

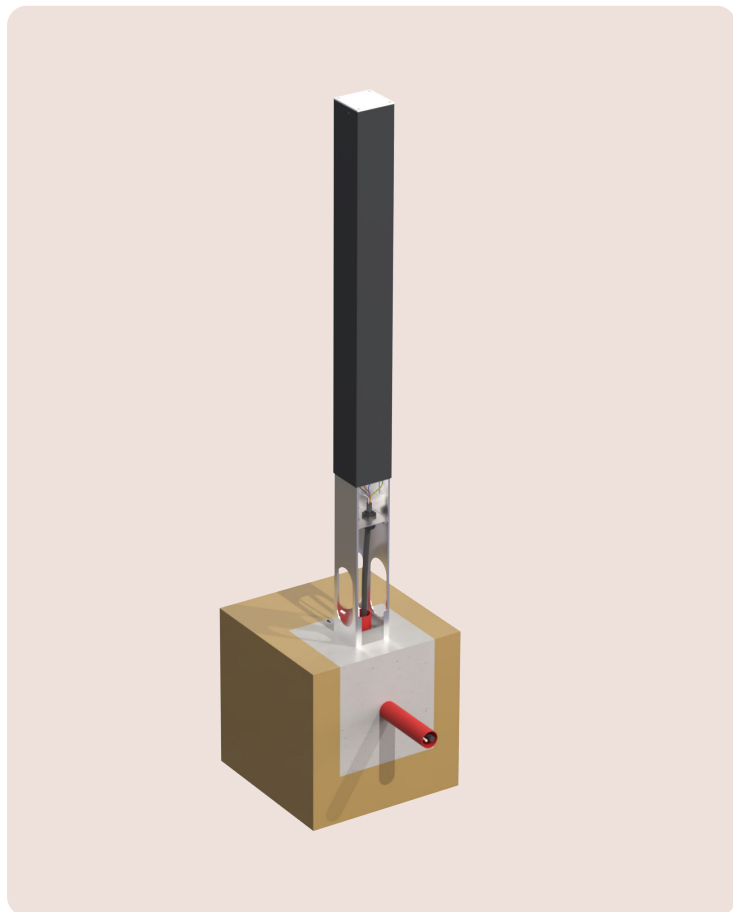

19

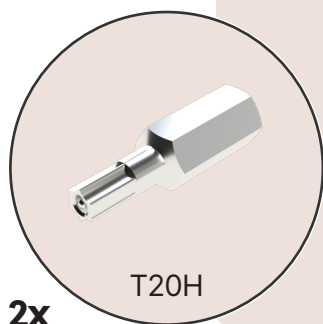

2x

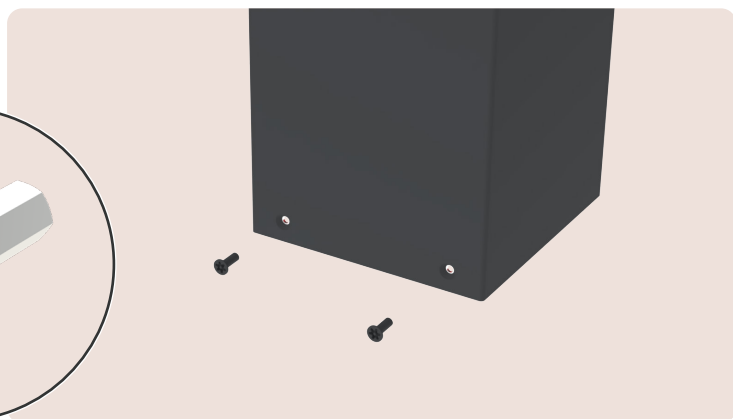

20

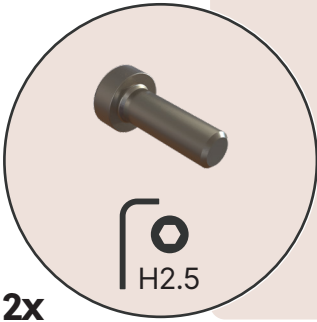
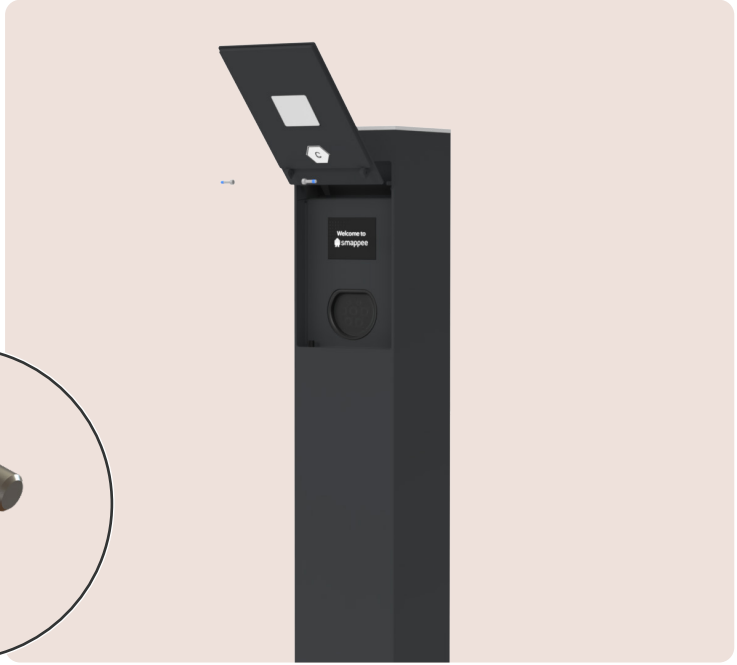

2x

21





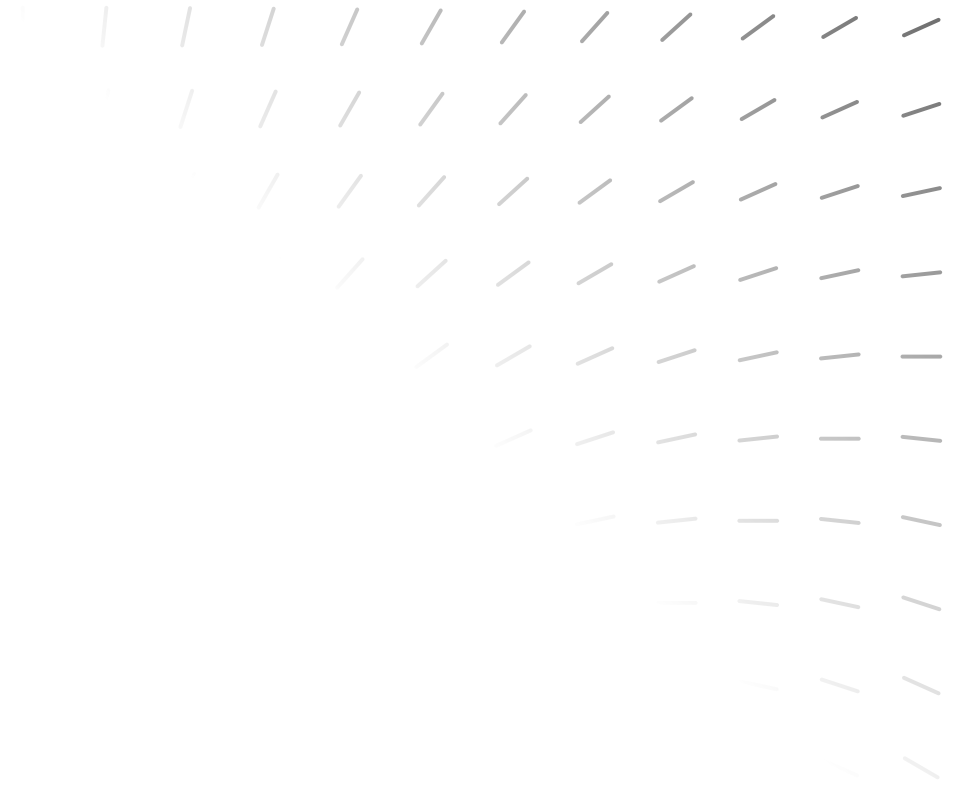

Please don't litter. Responsible publisher: Stefan Grosjean.
©Smappee NV Evolis 104 - 8530 Harelbeke, Belgium.
QIG EV One - 70-0207 - 2026/07

